



4010DUO User's Manual (V2.8)

Index

- User Notice - 4 -**
 - Safety Notes - 4 -
 - Copyright - 4 -
 - 4010DUO Special Features - 5 -
 - Appearance Parameters..... - 5 -
 - Specifications..... - 5 -
- Device Introduction - 6 -**
 - 4010DUO Parts & Interface Introduction..... - 6 -
 - 4010DUO Buttons Function & Icons Description..... - 6 -
 - 4010DUO Standard Accessories..... - 8 -
 - 4010DUO Optional Accessories..... - 8 -
- The Order of Connection for Charger - 9 -**
 - The Power Input Ground Cannot be Connected With the Output Ground..... - 9 -
 - Single-channel (CH1 or CH2) Connection Notes..... - 9 -
 - ◆ Connection for One Battery Pack - 9 -
 - ◆ Connection for Two Battery Packs..... - 10 -
 - Dual-channel Connection Notes - 10 -
 - ◆ Connection for Channel Asynchronous Mode - 10 -
 - ◆ Connection for Channel Synchronous Mode - 11 -
- iCharger Charge/Discharge Setup & Use - 12 -**
 - Power Supply Setup..... - 12 -
 - Program Add & Manage - 13 -
 - Run Program for Charger..... - 13 -
 - Program Running Status - 14 -
 - Error Messages - 15 -
 - Program Edit..... - 15 -
 - ◆ LiPo/LiIo/LiFe Battery Charge/Discharge Setup..... - 16 -
 - LiPo/LiIo/LiFe Battery Charge Setup - 16 -
 - ☞ LiPo/LiIo/LiFe Battery Not Balance Charge Setup..... - 17 -
 - ☞ LiPo/LiIo/LiFe Battery Balance Charge Setup..... - 17 -
 - ☞ LiPo/LiIo/LiFe Battery Charge Advanced Setup - 19 -
 - ☞ LiPo/LiIo/LiFe Battery Charge Safety Setup - 19 -
 - LiPo/LiIo/LiFe Battery Storage Setup..... - 19 -
 - LiPo/LiIo/LiFe Battery Discharge Setup..... - 20 -
 - ☞ To Channel Setup - 20 -
 - ☞ LiPo/LiIo/LiFe Battery Discharge Advanced Setup..... - 20 -
 - ☞ LiPo/LiIo/LiFe Battery Discharge Safety Setup..... - 21 -
 - LiPo/LiIo/LiFe Battery Cycle Setup - 21 -
 - LiPo/LiIo/LiFe Battery Only Balance Feature - 21 -
 - ◆ NiMH/NiCd Battery Charge/Discharge Setup - 21 -
 - NiMH/NiCd Battery Charge Setup..... - 22 -



- NiMH/NiCd Battery Charge Advanced Setup..... - 22 -
- NiMH/NiCd Battery Charge Safety Setup - 22 -
- NiMH/NiCd Battery Discharge Setup..... - 23 -
- NiMH/NiCd Battery Discharge Safety Setup..... - 23 -
- NiMH/NiCd Battery Cycle Setup..... - 23 -
- ◆ Pb Battery Charge/Discharge Setup..... - 23 -
- Pb Battery Charge Setup - 23 -
- Pb Battery Charge Advanced Setup..... - 24 -
- Pb Battery Charge Safety Setup - 24 -
- Pb Battery Discharge Setup..... - 24 -
- Pb Battery Cycle Setup..... - 24 -
- ◆ NiZn Battery Charge/Discharge Setup..... - 24 -
- NiZn Battery Charge Setup - 25 -
- NiZn Battery Not Balance Charger Setup - 25 -
- NiZn Battery Balance Charge Setup - 25 -
- NiZn Battery Charge Advanced Setup - 25 -
- NiZn Battery Charge Safety Setup - 25 -
- NiZn Battery Discharge Setup..... - 25 -
- To Channel Setup - 25 -
- NiZn Battery Discharge Advanced Setup..... - 26 -
- NiZn Battery Discharge Safety Setup - 26 -
- NiZn Battery Cycle Setup - 26 -
- 4010DUO Parameters Setup - 27 -**
- 4010DUO Parameters Setup..... - 27 -
- ◆ Charger Setup..... - 27 -
- Temp. & Fans Setup - 27 -
- Beep Tone Setup..... - 28 -
- LCD Setup..... - 28 -
- Output Power Setup..... - 28 -
- Power Supply Setup - 29 -
- Save & Load Configuration Setup - 29 -
- Communication Settings - 30 -
- Calibration..... - 30 -
- ◆ Extra Function..... - 31 -
- Log Files Manage..... - 31 -
- Servo Test..... - 32 -
- Pulse Measurement..... - 33 -
- USB & SD Card Use - 33 -
- Warranty & Service..... - 33 -
- 4010DUO Firmware Upgrades..... - 34 -**
- Use Logview for 4010DUO - 36 -**
- Communication Steps - 36 -
- Important Notes..... - 38 -**
- The Charging Principle for Reflex Charge Mode..... - 38 -
- Power Regenerative Mode..... - 38 -



- Channel Regenerative Mode..... - 38 -
 - ◆ Resistance or Bulbs..... - 38 -
 - ◆ Charging Battery - 39 -
- Lithium Battery Extra Discharge Mode..... - 39 -
- Appendix - 40 -**
 - Status Indication of Running Channel - 40 -
 - Status Indication of Channel Control..... - 40 -
 - Error Messages - 41 -



User Notice

● Safety Notes

Please read the entire Manual completely before using, to make sure you can use this device properly and more safely.



1. 4010DUO is a dual port charger, but this does not mean you can charge/discharge any configuration of the two sets of batteries! You must follow these rules: two battery packs without any external electrical connections, otherwise they could permanently damage the charger or batteries. For example: when charging a 12-cell battery pack, you must split it into two separate 6-cell, and you must never charge two 6-cell battery packs in series by connecting with CH-1 and CH-2 respectively.



2. 4010DUO input power cannot have fast voltage/current fluctuations, which may cause output over current, and will damage the charger and/or the batteries and input power source in extreme cases. For example: setting the input protection current and voltage is necessary according to the specifications of the input power supply, in order not to cause power overload. Some power supply overload protection circuits will produce substantial fluctuations in the supply voltage.

3. Keep the charger away from children and pets at all times.
4. Never leave the charger unsupervised when charging or discharging. If you leave, disconnect the battery and switch off charger to prevent any unexpected dangers or damage.
5. Ensure the charger program and settings match the battery pack otherwise the battery will be damaged and a dangerous situation may arise, especially for Lithium batteries, which may cause a fire.
6. Do not mix batteries of different types, different capacities or from different manufacturers.
7. Do not disassemble the charger.
8. Do not place the charger or any battery on a flammable surface or near a combustible material while in use. Do not charge or discharge on a carpet, cluttered workbench, paper, plastic, vinyl, leather or wood, inside an R/C model or inside a full-sized automobile.
9. Never block the air intake holes and never use in a refrigerated or high temperature environment. If used in such an environment, the internal temperature protection may result in abnormal charging/discharging that could be dangerous.
10. Do not allow water, moisture, metal wires or other conductive material into the charger.
11. Never charge or discharge any battery having evidence of leaking, expansion/swelling, damaged outer cover or case, color-change or distortion.
12. Do not try to charge “non-rechargeable” dry cells.
13. Do not exceed the battery manufacturer’s suggested maximum charge rates.
14. Carefully follow the battery pack manufacturer’s recommendations and safety advice.

● Copyright

Copyright© 2012 Shenzhen New Junsi Electronic Co., Ltd. All Rights Reserved.

Without prior written consent by Shenzhen New Junsi Electronic Co., Ltd, any units or individual extracts or copies of part or the entire contents of this manual, and transmission in any form is illegal and strictly prohibited.

The product described in this manual may include copyright software ownership belonging to Shenzhen New Junsi Electronic Co. Ltd and its licensee, except with the express permission from relevant rights holders, otherwise, any copying, distribution, modification, excerpt, de-compilation, disassembly, decryption, reverse engineering, lease,



transfer, sub-license, as well as other acts of infringement of software copyright is strictly prohibited, but apart from the restrictions prohibited by applicable law.

● **4010DUO Special Features**

1. The 4010DUO uses advanced Synchronous buck-boost DC/DC converter technology, high power, a high current and high-performance power conversion circuit. The maximum charge power capacity is up to 2000W, the maximum charge/discharge current of a channel is up to 40A, and two channels in Synchronous Mode are up to 70A.
2. Channel Supports 10s LiPo, Lilo, LiFe, NiZn, with maximum 1.2A balance current, and adopts a unique balance calculation of internal resistance correction.
3. Intelligent fan control. Sensing internal temperature via the internal temperature sensor, to thereby control the fan speed.
4. When the channel output connects the battery after the charger powers on, it will start automatically the anti-sparking protection (the chargers with V2.05 above firmware version) .
5. Internal temperature protection. When the internal temperature exceeds the Power Reduce temperature, the output power is automatically reduced; and the charger will shut down when temperature exceeds the Shut-down temperature.
6. This charger can save 64 parameters sets and support the data import/export to SD card.
7. A 2.8-inch LCD screen provides rich information including current, voltage, power, capacity, internal resistance, control status, time-consuming and temperature, etc.
8. Multi-discharge features: self-discharge, regenerative to input discharge, regenerative to channel discharge, and lithium battery extra expanding discharge.
9. Supports measurement for internal resistance of battery offline and online. Can measure not only the internal resistance of the entire battery pack, but also measure the internal resistance of each cell within the lithium battery.
10. The iCharger has protection for reversed polarity (input or output), input voltage/current, battery temperature, charging capacity, overrun time and maximum power etc.
11. Supports upgrading the hardware program by USB port. The iCharger also supports the “Logview” software and can display, plot and analyze the charge and discharge data by it. (See detail information about Logview at the following website: <http://www.logview.info>)

● **Appearance Parameters**

Net weight:	1.47kg
Dimension:	210.0×140.1×80.2 ±0.5mm

● **Specifications**

Input voltage range:	9.0—50.0VDC
Maximum input current limit:	<65A
Maximum charge/discharge current:	70A@Syn. Mode 40A@Asyn. Mode
Maximum charge power capacity:	2000W (Channel 1400W @input > 23.5V)
Maximum discharge power capacity:	200W (Channel 130W)
Maximum regenerative discharge power capacity:	2000W (Channel 1400W)
Maximum extra discharge power capacity:	3200W (Channel 1600W @40V/40A)
Maximum current drain for balancing:	2.4A@Syn. Mode 1.2A@Asyn. Mode



Device Introduction

● 4010DUO Parts & Interface Introduction

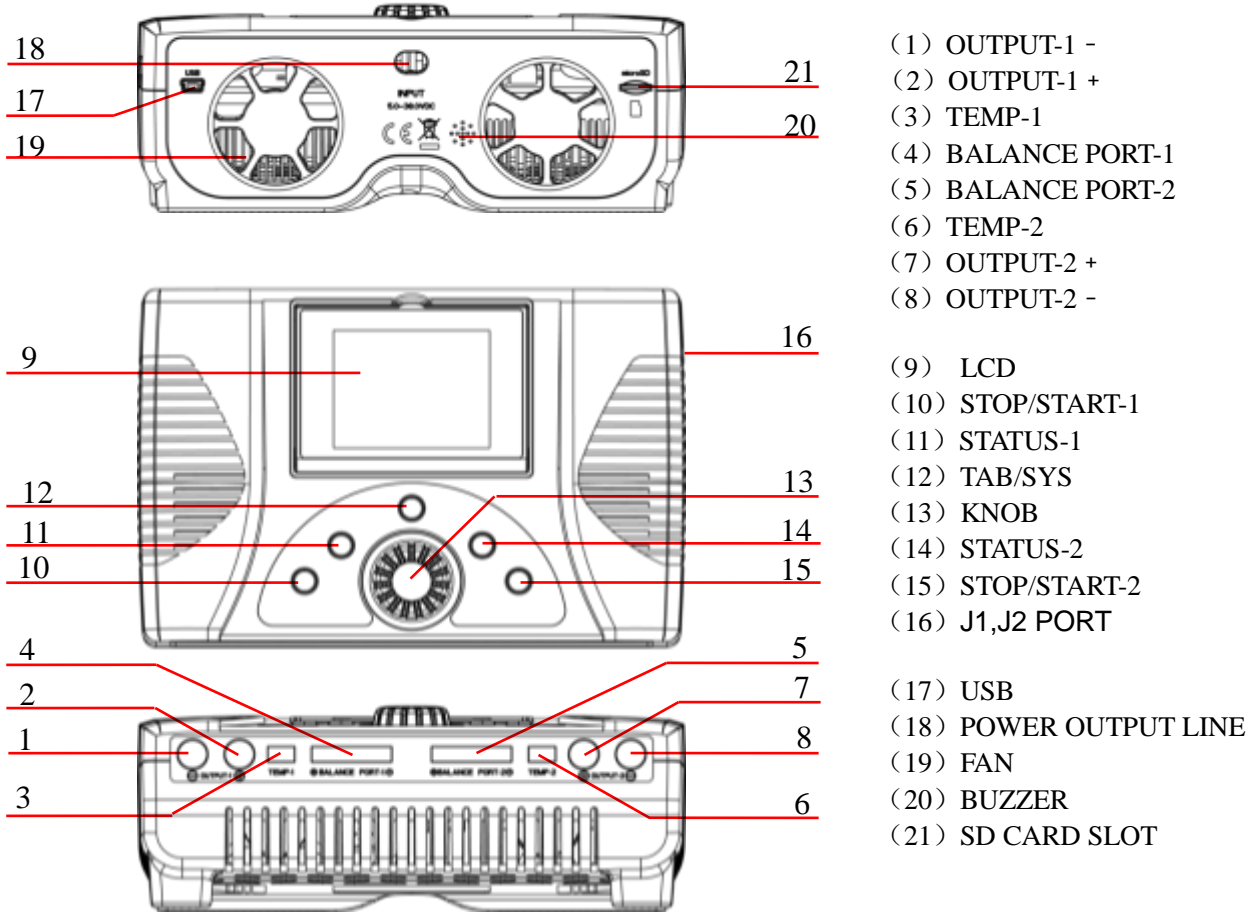



● 4010DUO Buttons Function & Icons Description

Buttons allow quick access to certain features when using 4010DUO, familiarity with the icons on the interface will help you better understand the working status of the charger, as shown in following chart:







Name	Functions & Use
KNOB	Press: confirm Counterclockwise rotation: up Clockwise rotation: down Long press: pop up manage menu via long press on <i>BATTERY MEMORY SELECTION</i> interface exit the program after saving via long press on <i>BATTERY SETUP</i> interface
TAB/SYS	Long press: enter <i>SYSTEM MENU</i> via long press on initial interface, and return to the previous menu via long press on the rest interface Click: can act as backspace when editing program name on <i>MEMORY SETUP</i> , and return to the previous menu via clicking on the rest interface





STATUS-1	<p>Long press: measure internal resistance of CH-1 via long press on initial interface, and to pop up the parameters setup interface via long press when running program</p> <p>Click: switch to the information display of CH-1 when running program</p>
STATUS-2	<p>Long press: measure internal resistance of CH-2 via long press on the initial interface, and to pop up the parameters setup interface via long press when running program</p> <p>Click: switch to the information display of CH-2 when running program</p>
STOP/START-1	<p>Click: click on the initial interface to enter <i>CH-1-BATTERY MEMORY SELECTION</i>, and click again to return the initial interface</p> <p>Long press: long press on the initial interface to enter the last running program of <i>Run Program</i> on CH-1, and long press again to run the selected program</p>
STOP/START-2	<p>Click: click on the initial interface to enter <i>CH-2-BATTERY MEMORY SELECTION</i>, and click again to return the initial interface</p> <p>Long press: long press on the initial interface to enter the last running program of <i>Run Program</i> on CH-2, and long press again to run the selected program</p>
STATUS-1+STOP/START -1	Press simultaneously on initial interface to enter <i>CH-1-MONITOR SETTINGS</i> on CH-1
STATUS-2+STOP/START -2	Press simultaneously on initial interface to enter <i>CH-2-MONITOR SETTINGS</i> on CH-2
STOP/START -1+STOP/START -2	Long press simultaneously on <i>Run Program</i> interface, two channels will run the same program simultaneously
	<p>Fan status: a. Grey shows not running</p> <p>b. Green shows running (the higher the green shows, the faster the fan runs, and vice versa)</p>
	<p>SD card status: a. Grey shows the SD card is not inserted</p> <p>b. Green shows the SD card has been inserted and can be used normally</p>
	<p>USB status: a. Grey for no USB connection</p> <p>b. Green for USB connection</p>



● **4010DUO Standard Accessories**

<p>USB data line #1</p>  <p>700mm</p>	<p>Power cable #1</p>  <p>600mm</p>
Standard mini USB data line	Power input cable
<p>Balance connector conversion board #2</p>  <p>70X44mm</p>	<p>Output cable #2</p>  <p>320mm</p>
Suit for Align/Dualshy battery etc.	Banana gold plug power output cable (single channel)
<p>Balance wire for balance board #2</p>  <p>150mm</p>	<p>CD-ROM #1</p> 
Suit for Align/Dualshy battery etc.	User's manual & Software
<p>Anti-slip rubber feet #4</p> 	
Anti-slip rubber feet to prevent the charger slipping.	

● **4010DUO Optional Accessories**

<p>Temperature sensor lead</p>  <p>350mm</p>	<p>Dual balance wires for balance board</p>  <p>150mm</p>
XP2.54 interface temperature sensor lead	11Pin-11Pin dual balance wire
<p>Dual channel output cable</p>  <p>350mm</p>	
Banana gold plug power output cable (two channels)	

The Order of Connection for Charger

- **The Power Input Ground Cannot be Connected With the Output Ground**

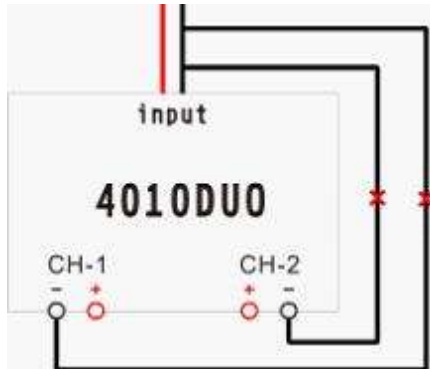

 Note: The input of power lead cannot be connected directly to the output (see left picture), and the voltage of the input power supply cannot have large instantaneous fluctuations, otherwise the charger will be damaged.

- **Single-channel (CH1 or CH2) Connection Notes**



4010DUO with the firmware version above V2.05 (including V2.05), please be sure to connect the input power first, after the charger starts the output anti-sparking protection (after electrifying 1 second), and then connect the battery.

4010DUO with the firmware version below V2.05 (excluding V2.05), please be sure to follow strictly the connection ways as below.

- ◆ **Connection for One Battery Pack**

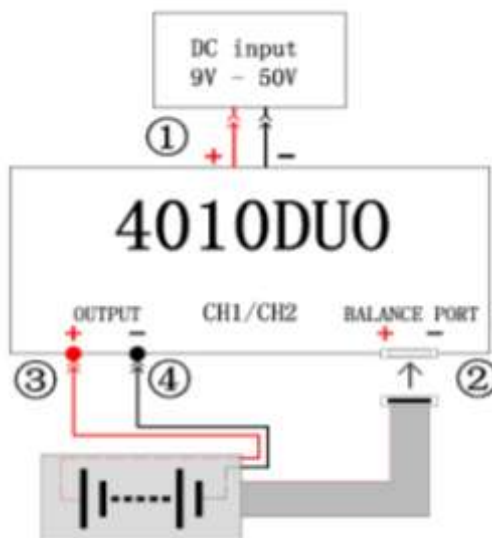

 Note: The left picture shows the correct order of connection, please be sure to follow the recommended order.

1. The spark is a normal phenomenon when connect with the power supply (The step ①), and the higher the input voltage, the greater the spark; you can turn off the power supply first, connect the step ①, then turn on the power supply to avoid the spark.
2. If connect in reverse order (step ②, ③, ④, ⑤), It will cause a greater spark when connect with battery.

◆ Connection for Two Battery Packs

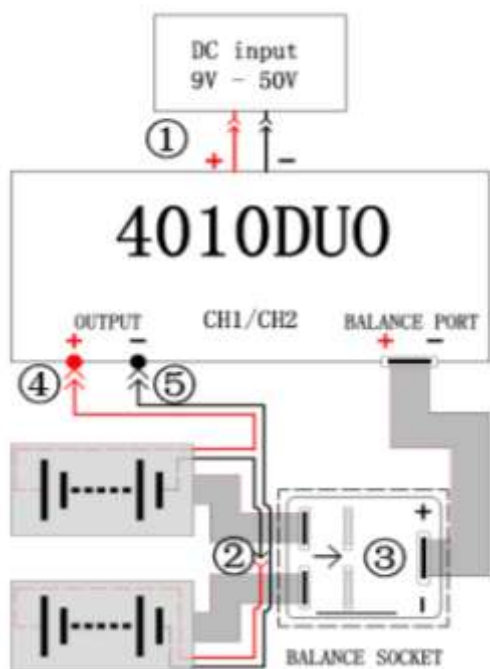

Note: The left picture shows the correct order of connection, please be sure to follow the recommended order.

1. The spark is a normal phenomenon when connect with the power supply (The step ①), and the higher the input voltage, the greater the spark; you can turn off the power supply first, connect the step ①, then turn on the power supply to avoid the spark.

2. If connect in reverse order (step ②, ③, ④, ⑤), It will cause a greater spark when connect with battery.



3. If step ④, ⑤ connected at first, next you must connect step ②, and then connect step ③, otherwise it will cause damage to the BALANCE PORT interface of the charger.

● Dual-channel Connection Notes

◆ Connection for Channel Asynchronous Mode

Channel Asynchronous Mode: i.e. CH-1 and CH-2 work independently.

Go to MEMORY SETUP → Option → Channel Mode to select Asynchronous.

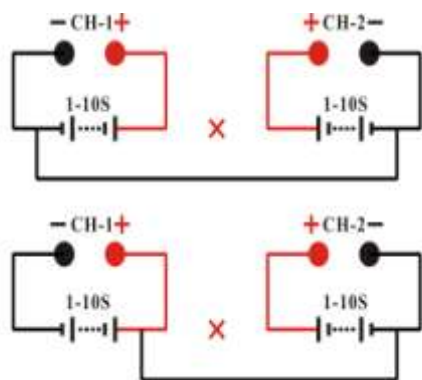

Picture1: Error Connection



Picture2: Correct Connection

Note: In this mode, the two channels must not have any external electrical connection; otherwise it will damage the charger. You cannot charge with connection shown in picture 1, the correct connection is shown in picture 2.



◆ Connection for Channel Synchronous Mode

Channel Synchronous Mode: i.e. CH-1 & CH-2 are controlled at the same time to charge/discharge one battery pack. Go to *MEMORY SETUP*→*Option*→*Channel Mode* to select *Synchronous*.

In this mode, the maximum current can be up to 70A, power capacity is the sum of both channels' limits

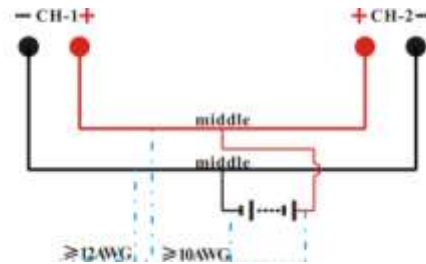

- 1: The total voltage of dual-channel
- 2: The total current of dual-channel
- 3: The total capacity of dual-channel
- 4: Channel current & voltage difference

Note: The two channels charge one battery pack simultaneously must be connected as shown in the left picture and the two channels must work in synchronous mode, otherwise the charger will be damaged.

iCharger Charge/Discharge Setup & Use

4010DUO iCharger can charge/discharge LiPo, Lilo, LiFe, NiHM, NiCd , Pb or NiZn batteries, this manual is divided into three parts to explain and introduce the charger’s features for LiPo/Lilo/LiFe, NiHM/NiCd , Pb,NiZn batteries.

● Power Supply Setup

The charger boots automatically when the power is turned on and the initial interface will display LOGO, charger relevant information, power source and message etc.

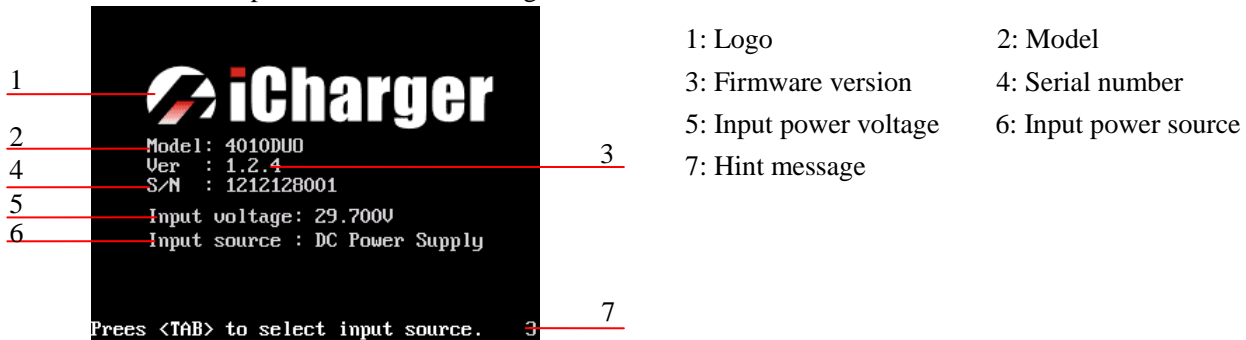



System will delay **5 seconds** after booting, during this period, press **TAB / SYS** button to change the input source type, while pressing any other buttons to enter the initial interface.

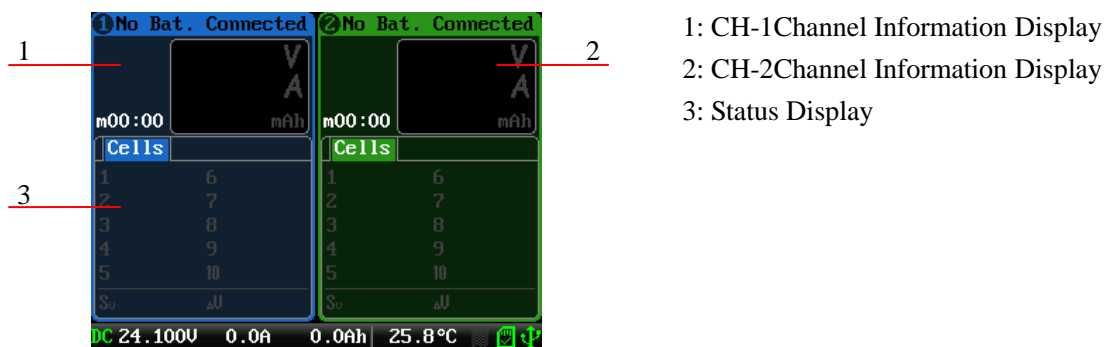

 Note: Set type of input power supply in *SYSTEM MENU* → *Charger Setup* → *Power Supply*; see details on [Page27 4010DUO Parameters Setup](#).

After selecting the input power supply, confirm and enter the initial interface.



 Note: The specific display of each region can refer to the introduction on [Page14](#) & [Page15](#) Program Running Status & Error Messages.



● Program Add & Manage

Click **STOP/START-x** button on the initial interface to pop up the **BATTERY MEMORY SELECT** window.

4010DUO has 6 built-in programs before it enters to the market (shown in following picture), which cannot be deleted and are limited for editing. The built-in programs are underline to distinguish them from the customized programs set by the user.

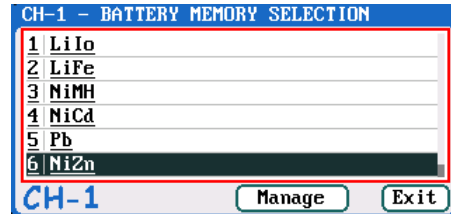

Click "**Manage**" (or long press **KNOB**) to pop up the **MANAGE** after exiting focus via pressing **TAB/SYS**, and click "**Edit**" to enter **MEMORY SETUP** to edit the program, or click "**Add**" to add new program and enter its editing interface at the same time.



Note: If the program selected is a built-in program, "Copy From..." and "Delete" options are shown as inactive status, and unable to be set.

● Run Program for Charger

After selecting program on **BATTERY MEMORY SELECTION**, click to enter **Run Program** interface (long press **STOP/START-x** button on the initial interface will enter **Run Program** from the last running program), as below:

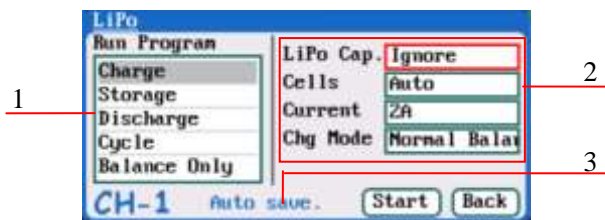

- 1: Run Program Selection
- 2: Common Parameters Setup
- 3. Auto- save Hint

Note: 1. The common parameters of built-in program will be saved by default automatically to the running program, while the program customized by the users can be set to be saved or not in **MEMORY SETUP**→**MEMORY OPTION**→*Auto save before the program runs*.

2. After setting the Cap. value, when the Current value exceeds the certain value, the system will be a warning display and alarm voice (shown in the following picture). The Current value of each battery type is: LiX battery :> 3C, NiMH/NiCd battery :> 2C, Pb battery :> 0.3C, NiZn battery>2C.

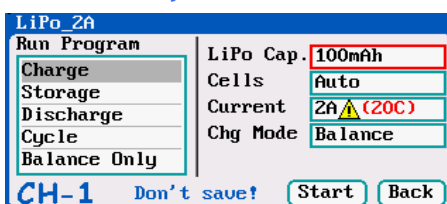



After selecting the program to run, click confirmation to pop up *RUN PROGRAM* window, as below:

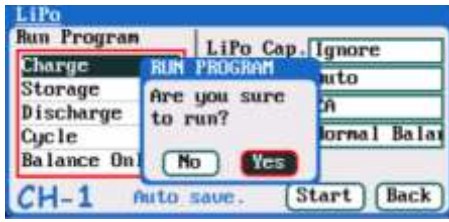

Click *Yes* to run the program, click *No* to cancel.

● Program Running Status



- 1: Running program name
 - 2: Battery type
 - 3: Running channel status
 - 4: Channel control status/external temperature
 - 5: Running program time
 - 6: Multipage information
 - 7: Charging voltage
 - 8: Charging current
 - 9: Charging capacity
 - 10: Balance strength
 - 11: Input power source type
 - 12: Input voltage
 - 13: Input current
 - 14: Input capacity
 - 15: Internal temperature
 - 16: Fan status
 - 17: SD card status
 - 18: USB status
- See details on Page40 Status Indication of Running Channel & Status Indication of Channel Control.

Press *STATUS-x* button when running program to switch the multipage information displays, as below:

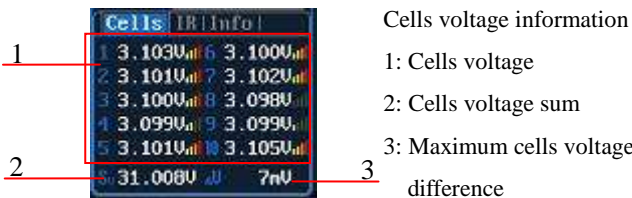

- Cells voltage information
- 1: Cells voltage
 - 2: Cells voltage sum
 - 3: Maximum cells voltage difference



- IR information
- 1: Cell internal resistance
 - 2: Pack internal resistance
 - 3: Line resistance

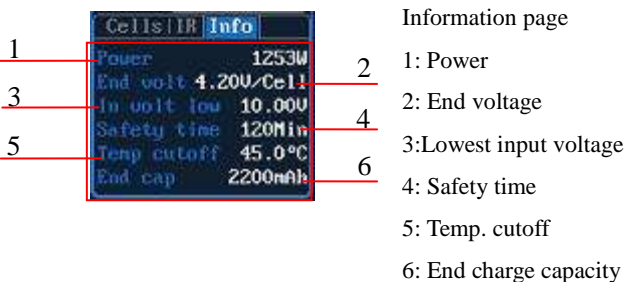

- Information page
- 1: Power
 - 2: End voltage
 - 3: Lowest input voltage
 - 4: Safety time
 - 5: Temp. cutoff
 - 6: End charge capacity

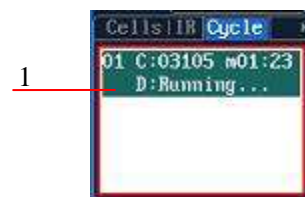

- Cycle charge status
- 1: Cycle charge status

Note: Different types of batteries and programs have different multipage information displays, see details below:

Types of battery	Cells	IR	Info	Cycle
LiPo/Lilo/LiFe	✓	✓	✓	✓
NiMH/NiCd	×	×	✓	✓
Pb	×	×	✓	✓
NiZn	✓	✓	✓	✓

Press **STATUS-x** button for **2 seconds** when running program to pop up **MODIFY** interface, to modify the current and discharge voltage parameters online, as below:



Press **STOP/START-x** button when running program to stop running, and press **STOP/START-x** button again to return to the initial interface.

● Error Messages

During the running program, if the system detects an error, it will stop the program on the channel immediately and pop up the red dialog box and the buzzer alarms, as below:

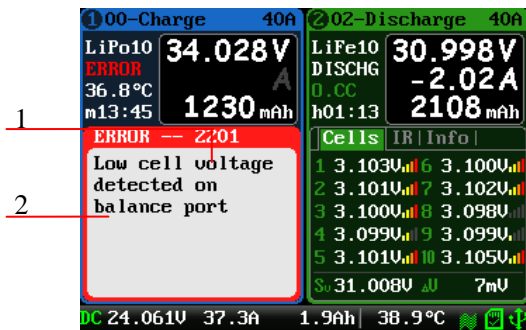

- 1: Error number
 - 2: Error message
- See all details on Page41 [Error Messages](#).

● Program Edit

After adding new programs or editing saved programs, the system will enter **MEMORY SETUP** interface. Users can set or modify the program on this interface.

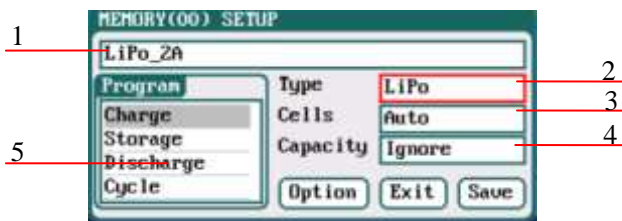

- 1: Program name
- 2: Battery type
- 3: Number of cells
- 4: Battery capacity
- 5: Available program

 **Note:** 1. When editing the program name, the character can be selected by turning the **Knob**, and clicking the **Knob** to confirm the selected character. Clicking **TAB/SYS** button will delete the character. Double-click **Knob** after editing program name. If the program name is empty, the system will name it automatically.

2. If the Editing program is the built-in program, the program name and the types of battery parameters cannot be changed.

After setting the basic parameters of a battery, click "**Option**" to enter **MEMORY OPTION** interface, after setting click "**Back**" to return to **MEMORY SETUP**, and click "**Save**" to save.

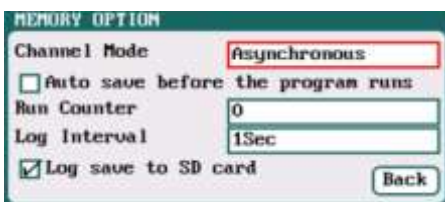

- Channel Mode: Asynchronous (default);
Synchronous
- Run Counter: 0-999; default: 0
- Log Interval: 0.5-60Sec; default: 1Sec



Note: 1. Channel Mode has asynchronous, synchronous available, see more details on Page10
Dual-channel Connection Notes.

- 2. If select synchronous mode, the maximum current setting will change from 40A to 70A.
- 3. If tick *Auto saves before the program runs*, the parameters set on the *Run program* will be saved automatically, and the *Run Program* will display "Auto save" (shown in the following left picture), otherwise it will display "Don't save!" (shown in the following right picture); for built-in program, the *Auto save before the program runs* option is ticked by default.
- 4. If tick *Log save to SD card*, the log files will be saved to SD card when running program, and vice versa.

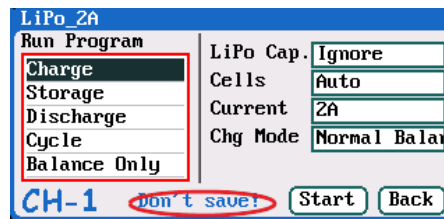
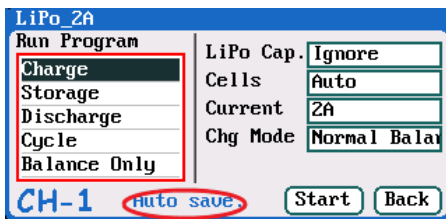

◆ LiPo/LiIo/LiFe Battery Charge/Discharge Setup

After adding a program, it will switch to LiPo/LiIo/LiFe battery in *Type* option on the *MEMORY SETUP* interface, and set the number of *cells* and *capacity*, if there is no setting for the number of cells, the charger will set *Auto* by default. After editing all parameters for the program, click "Save" to save and return to the previous interface.

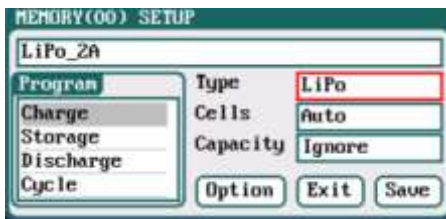

Cells: Auto(default), 1-10S

As shown in the above picture, the program of LiPo, LiIo, LiFe battery has: *Charge, Storage, Discharge, Cycle and Balance Only.*

□ LiPo/LiIo/LiFe Battery Charge Setup

Select *Program*→*Charge* to enter *Charge* setup interface.



Chg Current: 0.05A-40A; default: 2A
 Chg Mode: *Slow Balance, Normal Balance(default), Fast Balance, User Balance, Not Balance*
 Chg End Current: 1%-50%; default: 10%
 Chg Cell Volt: 3.85V/Cell-4.35V/Cell;
 Default: 4.2V/Cell



- Note:1. When the value of charge cells voltage exceeds the recommended value (LiPo 4.2V, Lilo 4.1V, LiFe 3.6V), the charger will sound an alarm with beep tones. As long as the user changes the values, the battery types and cells voltage value on the main charging interface will be displayed alternately.
- 2. For the setting process for all program in this manual, tick **Show** to display the setting program on **MEMORY SETUP** (shown in the following picture), and vice versa; the built-in program is ticked by default.

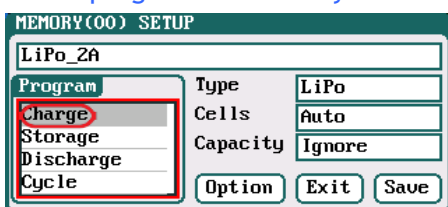

LiPo/LiIo/LiFe Battery Not Balance Charge Setup

When switch to *Not Balance* on *Chg Mode*, Only *Chg End Current* is available for charging end condition, and "Set..." behind *Chg Mod* and *Chg End Current* are inactive.

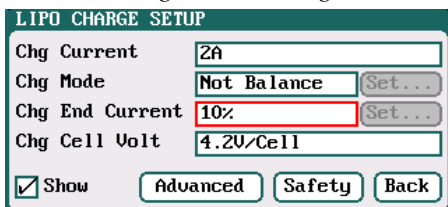

- Note: 1. The charger first charges with constant current (CC) according to the user setting, then turns to constant voltage (CV) when the charging voltage reaches the peak point. In the CV phase the current gradually falls, and the charger will terminate charging when the current falls below the percentage of the configured charge current. For example: the default value of Chg Current is 2A, and the default value of Chg End Current is 10%

$$\begin{aligned} \text{Chg End Current} &= 2\text{A} * 10\% \\ &= 0.2\text{A} \end{aligned}$$

Therefore it stops charging when the charging current reduces to 0.2A.

LiPo/LiIo/LiFe Battery Balance Charge Setup

When switch to *Slow Balance*, *Normal Balance*, *Fast Balance* or *User Balance* on *Chg Mode* to activate "Set..." button and click it to enter *Balance* mode setup interface.

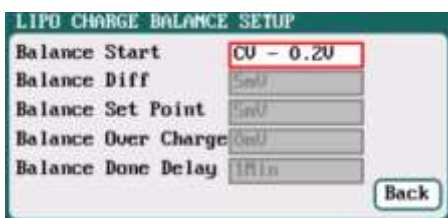

Balance Start : CV, CV-0.1V—1V, Always
Default: CV-0.2

If the balance charge voltage is 4.2V, Balance Start set to CV-0.2V; therefore the charger will start to balance the battery cells when the voltage reaches to 4.2V-0.2V=4V

- Note: On *Balance* mode, the charger will monitor the voltage of individual cells to control it within the Chg Cell Volt and equalize the voltage in all cells, to avoid some cell voltage over-charged or not full. When selecting *Balance* mode, the balance port of charger or balance board must be connected with battery except for connecting 1S battery.



When switch to *User Balance* mode on *Chg Mode*; the *Balance Diff*, *Balance Set Point*, *Balance Over Charge* and *Balance Done Delay* are available, after setting, click "Back" to return to the previous interface.

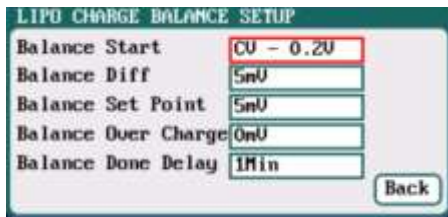

- Balance Diff: 1mV-10mV; default: 5mV
- Balance Set Point: 1mV-50mV; default: 5mV
- Balance Over Charge: 0mV-50mV; default: 0mV
- Balance Done Delay: 0Min-20Min; default: 1Min



Note: If *Balance Diff* value is lower, the voltage difference between cells will be lower and the balancing will take more time before the program ends. If *Balance Set Point* value is lower, the battery will be closer to the setting cut-off voltage and the time taken will be longer before the program ends. *Balance Over Charge*, the maximum overcharge compensation voltage acts as accelerated charge, and the larger the value, the more obvious the accelerated charge. For example: Charge Lipo with V_{std} , set *Balance Over charge* to V_{boc} , the cell's internal Resistance detected is R_i , when the charge current is I_a , the actual CV value of cells is V_a

$$\text{IF } R_i \cdot I_a > V_{boc} \text{ THEN}$$

$$V_a = V_{std} + V_{boc}$$

$$\text{ELSE}$$

$$V_a = V_{std} + R_i \cdot I_a$$

Please set this parameter after understanding fully, or keep the default value at 0.

The value of *Balance Done Delay* is larger; the battery is closer to the setting cut-off voltage when the program ends.

Switch to *Balance charge mode* on *Chg Mode*, and click "Set..." behind *Chg End Current* to enter *CHARGE BALANCE End SETUP* interface for setting.

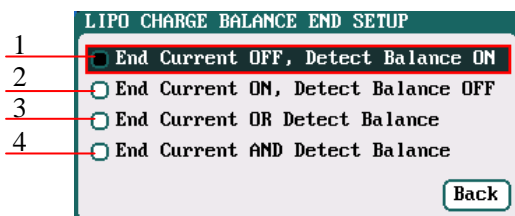

- 1: The charger will stop balance charge if detects the Balance condition is met, and the End Current condition is invalid
- 2: The charger will stop balance charge if detects the End Current condition is met, and the Balance condition is invalid
- 3: The charger will stop balance charge if detects the End Current condition or the Balance condition is met
- 4: The charger will stop balance charge if detects the End Current condition and the Balance condition are met



➤ LiPo/LiIo/LiFe Battery Charge Advanced Setup

Click "Advanced" to enter *LiPo/LiIo/LiFe ADVANCED SETUP*, after setting, click "Back" to return to the previous interface.

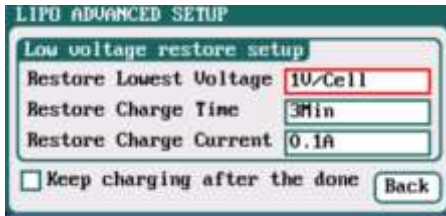

Restore Lowest Voltage:

0.5V/Cell-2.5V/Cell; Default: 1V/Cell

Restore Charge Time:

1Min-5Min; default: 3Min

Restore Charge Current:

0.02A-0.5A; default: 0.1A

- Note: 1. When charging the over-discharged battery, the charger will detect if the cell voltage is larger than the restore voltage, if larger, it will pre-charge the battery with restore current, if within the setting restore time, the cell voltage rises to the normal value then it will turn to the charging program; otherwise it will stop running.
- 2. After charging, the battery may not be completely charged; tick *Keep charging after the done* to charge the battery with smaller current when charging ends.

➤ LiPo/LiIo/LiFe Battery Charge Safety Setup

Click "Safety" to enter *CHARGE SAFETY SETUP*, after setting click "Back" to return to the previous interface.

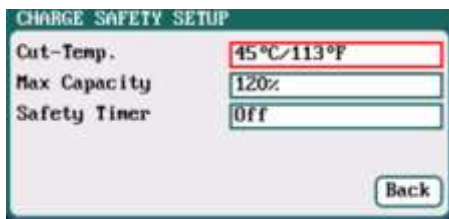

Cut-Temp: *20 °C-80 °C; default: 45 °C*

Max Capacity: *50%-200%; default: 120%*

Safety Timer: *0Min-9999Min; default: off*

- Note: *Cut-Temp.* is the maximum safety temperature of the battery. If the temperature sensor detects the set value, the program will stop running in order to protect the battery from being damaged by high temperature.

☐ LiPo/LiIo/LiFe Battery Storage Setup

This mode is for storing LiPo/LiIo/LiFe battery that will not to be used for an extended period. The charger determines whether to charge or discharge the battery based on the configured target voltage. If the battery voltage exceeds the target storage voltage it will start to discharge, while lower than the target storage voltage it will start to charge.

Select *Program*→*Storage* to enter *Storage* setup interface.

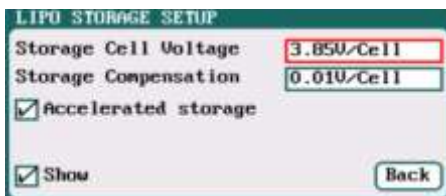

Storage Cell Voltage: *3.7V/Cell-3.9V/Cell;*

Default: 3.85V/Cell

Storage Compensation: *0V/Cell-0.2V/Cell;*

Default: 0.01V/Cell

- Note: 1. *Accelerated storage*: accelerated storage via internal resistance correction. Tick *Accelerated storage* to activate accelerated storage.
- 2. *Storage Compensation* is the compensation for the battery voltage fallback: for storage charge, the actual storage voltage=Storage Cell Voltage + Storage Compensation; for storage discharge, the actual storage voltage=Storage Cell Voltage - Storage Compensation.



LiPo/LiIo/LiFe Battery Discharge Setup

Select *Program*→*Discharge* to enter *Discharge* setup interface.

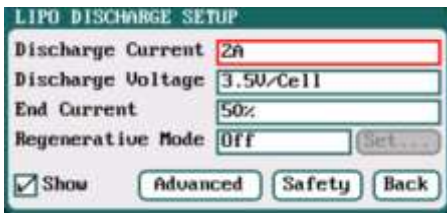

Discharge Current: 0.05A-40A; default: 2A

Discharge Voltage: 3V/Cell-4.1V/Cell;

Default: 3.5V/Cell

End Current: 1%-100%; default: 50%

Regenerative Mode: OFF (default), To input, To channel

Note: 1. The charger first discharges with constant current (CC) according to the user setting then turns to constant voltage (CV) when it reaches the discharge voltage. In the CV phase the current gradually falls, and the charger will terminate discharging when the current falls below the percentage of the configured discharge current.

2. Regenerative mode has three available settings: OFF, To input, To channel, see more details on Page38 Important Notes.

To Channel Setup

When selecting to *To channel* on *Regenerative Mode*, "Set..." button changes from inactive to its operational status, and click to enter *To channel* setup interface, after setting click "Back" to return to the previous interface

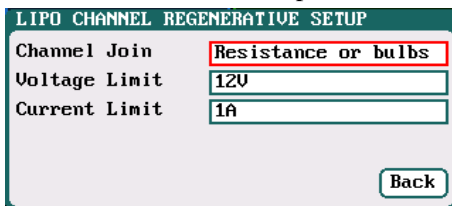

Channel Join: Resistance or bulbs (default)

Charging battery

Voltage Limit: 0.1V-40V; default: 12V

Current Limit: 0.05A-40A; default: 1A

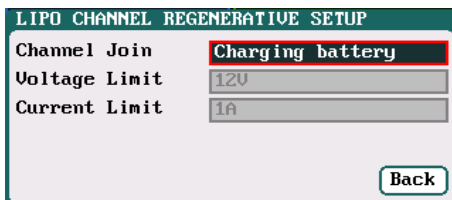

Note: 1. For example, a 12V/60W bulb as the load of To Channel, it should set Voltage Limit =12V; Current Limit=60/12=5A.

2. When the battery as the load of To Channel, Voltage Limit and Current Limit are not settable, see details on Page38 Channel Regenerative Mode.

LiPo/LiIo/LiFe Battery Discharge Advanced Setup

Click "Advanced" to enter *LiPo/LiIo/LiFe DISCHARGE ADVANCED SETUP* interface, after setting click "Back" to return to the previous interface.



Note: 1. Tick *Extra Discharge Enable* to activate *discharge enable*, see more details on Page39 Lithium Battery Extra Discharge Mode.

2. Tick *Balance Enable* to activate *balance discharge*; when discharge enters the CV phase, it starts to balance the cell voltages.



➤ LiPo/LiIo/LiFe Battery Discharge Safety Setup

Click "Safety" to enter DISCHARGE SAFETY SETUP, after setting click "Back" to return to the previous interface.

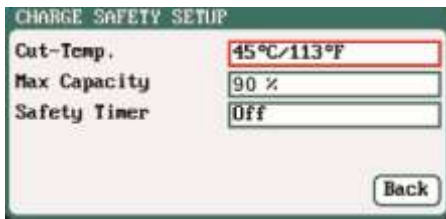

Cut-Temp: 20 °C-80 °C; default: 45 °C
Max Capacity: 50%-200%; default: 90%
Safety Timer: 1Min-9999Min; default: off

☐ LiPo/LiIo/LiFe Battery Cycle Setup

Select Program→Cycle to enter Cycle setup interface, after setting click "Back" to return to the previous interface.

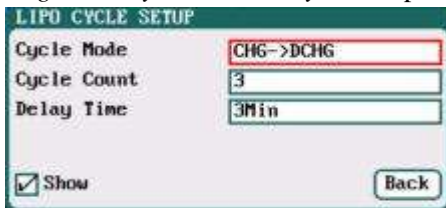

Cycle Mode:
CHG→DCHG(default), DCHG→CHG,
CHG→DCHG CHG, DCHG→CHG DCHG,
CHG→DCHG STO, DCHG→CHG STO
Cycle Count: 1-99; default: 3
Delay Time: 0Min-9999Min; default: 3Min

☐ LiPo/LiIo/LiFe Battery Only Balance Feature

Select Program→Balance Only to enter Balance Only setup interface, after setting click "Back" to return to the previous interface.



Note: Balance Only is the program only to equalize the individual cells through balance port to reduce the voltage difference.

◆ NiMH/NiCd Battery Charge/Discharge Setup

After adding a program, it will switch to NiMH/NiCd battery in Type option on the MEMORY SETUP interface. Set the capacity, the number of cells for NiMH/NiCd battery cannot be set, and the charger sets Auto by default, after editing all parameters for the program, click "Save" to save and return to the previous interface.

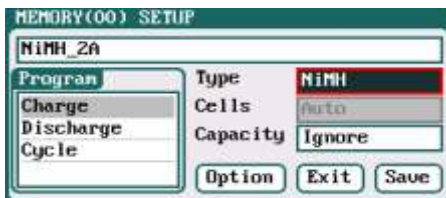

As shown in above picture, the program of NiMH, NiCd has the following modes: Charge, Discharge and Cycle.



❑ NiMH/NiCd Battery Charge Setup

Select *Program*→*Charge* to enter *Charge* setup interface.



Chg Current: 0.05A-40A; default: 2A
Chg Mode: Normal (default), Reflex

Note: Charge Mode has *Normal* and *Reflex* modes available; use reflex mode to charge the battery, it can reduce the heat in the battery; please see charging principle on Page38 Important Notes.

➤ NiMH/NiCd Battery Charge Advanced Setup

Click "**Advanced**" to enter *NiMH/NiCd CHARGE OPTION SETUP* interface, after setting click "**Back**" to return to the previous interface.



Sensitivity: 1mV-20mV; default: 3mV
Delay time: 0Min-20Min; default: 3Min

Note: For the over-discharged NiMH/NiCd battery, the voltage may be close to 0V, tick *Allow 0V Charging* to allow charge with 0V.

Tick *Trickle Enable*→*Enable* to activate trickle charge and set the parameters, after setting click "**Back**" to return to the previous interface.



Trickle current: 0.02A-1A; default: 0.05A
Trickle timeout: 1Min-999Min; default: 5Min

Note: Tick *Enable* to activate trickle charge.
Trickle charge means when the standard charge is completed, the charger will charge the battery with the setting trickle current until the setting trickle timeout, then to stop the charging process.

➤ NiMH/NiCd Battery Charge Safety Setup

Click "**Safety**" to enter *CHARGE SAFETY SETU* interface, see details about setting on Page19 LiPo/LiIo/LiFe Battery Charge Safety Setup.

❑ NiMH/NiCd Battery Discharge Setup

Select *Program*→*Discharge* to enter *Discharge* setup interface.



Discharge Current: 0.05A-40A; default: 2A
 Discharge Voltage: 0.1V-40V; default: 0.1V
 End Current: 1%-100%; default: 50%
 Regenerative Mode: OFF (default), To input, To channel

-  Note: 1. Regenerative mode has three modes available: OFF, To input, To channel. See more details on Page38 [Important Notes](#).
- 2. To channel Setup please see Page20 [To channel Setup](#).

➡ NiMH/NiCd Battery Discharge Safety Setup

Click "**Safety**" to enter *DISCHARGE SAFETY SETUP* interface, see details about setting on Page20 [LiPo/LiIo/LiFe Battery Discharge Safety Setup](#).

❑ NiMH/NiCd Battery Cycle Setup

Select *Program*→*Cycle* to enter *Cycle* setup interface, see details about setting on Page21 [LiPo/LiIo/LiFe Battery Cycle Setup](#).

◆ Pb Battery Charge/Discharge Setup

After adding program, it will switch to Pb battery in *Type* option on the *MEMORY SETUP* interface. Set the number of *cells* and *capacity*, after editing all parameters for program, click "**Save**" to save and return to the previous interface.

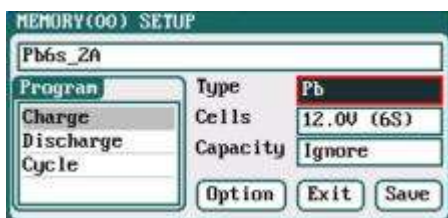

Cells: 1-15S; default: 6S

As shown in above picture, the program of Pb battery has the following modes: *Charge*, *Discharge* and *Cycle*.

❑ Pb Battery Charge Setup

Select *Program*→*Charge* to enter *Charge* setup interface.

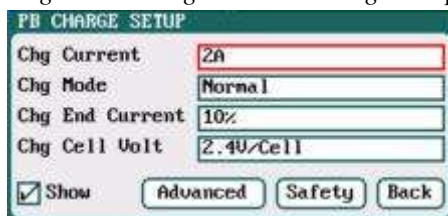



Chg Current: 0.05A-40A; default: 2A
 Chg Mode: Normal (default), Reflex
 Chg End Current: 1%-50%; default: 10%
 Chg Cell Volt: 2V/Cell-2.6V/Cell; Default: 2.4V/Cell

-  Note: 1.The charger first charges with constant current (CC) according to the user setting then turns to constant voltage (CV) when the charging voltage reaches the peak point. In the CV phase the current gradually falls, and the charger will terminate charging when the current falls below the percentage of the configured charge current.
- 2.Charge mode has *Normal*, *Reflex* two modes available, about the *Reflex* mode (Reflex) please see Page38 [Important Notes](#).

➤ **Pb Battery Charge Advanced Setup**

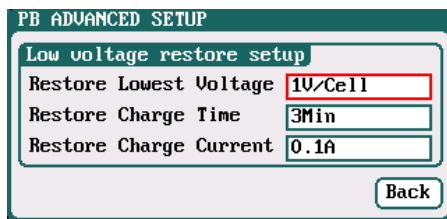
Click "**Advanced**" to enter *PB ADVANCED SETUP* interface



 **Note:** When charging the over-discharged battery, the charger will detect if the cell voltage is larger than the restore voltage, if larger, it will pre-charge the battery with restore current, if within the setting restore time, the cell voltage rises to the normal value then it will turn to the charging program; otherwise it will stop running.

➤ **Pb Battery Charge Safety Setup**

Click "**Safety**" to enter *CHARGE SAFETY SETUP* interface, see details about setting on Page19 LiPo/LiIo/LiFe Battery Charge Safety Setup.

❑ **Pb Battery Discharge Setup**

Select *Program*→*Discharge* to enter *Discharge* setup interface, see details about setting on Page20 LiPo/LiIo/LiFe Battery Discharge Setup.

❑ **Pb Battery Cycle Setup**

Select *Program*→*Cycle* to enter *Cycle* setup interface, see details about setting on Page21 LiPo/LiIo/LiFe Battery Cycle Setup.

◆ **NiZn Battery Charge/Discharge Setup**

After adding a program, it will switch to NiZn battery in *Type* option on the *MEMORY SETUP* interface. Set the capacity, the number of cells for NiZn battery cannot be set, and the charger sets *Auto* by default, after editing all parameters for the program, click "**Save**" to save and return to the previous interface.

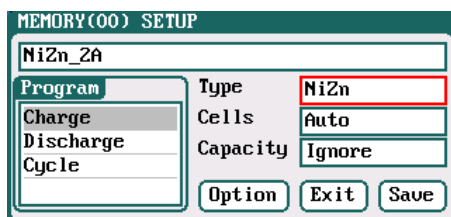

Cells: 1-8S; default: Auto

As shown in above picture, the program of NiZn has the following modes: *Charge*, *Discharge* and *Cycle*.

❑ NiZn Battery Charge Setup

Select *Program*→*Charge* to enter *Charge* setup interface.

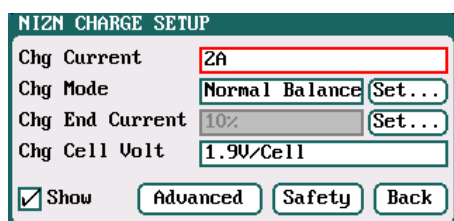

Chg Current: 0.05A-30A; default: 2A

Chg Mode: *Slow Balance, Fast Balance, Normal Balance, User Balance, Not Balance(default)*

Chg End Current

1%-50%; default:10%

Chg Cell Volt

1.2V/Cell-2V/Cell; default: 1.9V/Cell

 **Note:** When the battery cell charging voltage setting exceeds the recommended value (1.9V), there will be a warning display and alarm voice. As long as the user changes the value, the battery type and cell voltage values on the main interface of charger will display alternately.

➤ NiZn Battery Not Balance Charger Setup

Switch to *Not Balance* mode on *Chg Mode* interface, see details about setting on Page17 [LiPo/LiIo/LiFe Battery Not Balance Charge Setup](#).

➤ NiZn Battery Balance Charge Setup

Switch to *Slow Balance, Normal Balance, Fast Balance, User Balance* on *Chg Mode* interface, see details about setting on Page17 [LiPo/LiIo/LiFe Battery Balance Charge Setup](#).

➤ NiZn Battery Charge Advanced Setup

Click "**Advanced**" to enter *NIZN ADVANCED SETUP* interface, see details about setting on Page19 [LiPo/LiIo/LiFe Battery Charge Advanced Setup](#).

➤ NiZn Battery Charge Safety Setup

Click "**Safety**" to enter *CHARGE SAFETY SETUP* interface, see details about setting on Page19 [LiPo/LiIo/LiFe Battery Charge Safety Setup](#)

❑ NiZn Battery Discharge Setup

Select *Program*→*Discharge* to enter *Discharge* setup interface

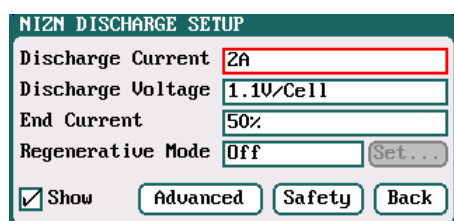

Discharge Current: 0.05A-30A; default: 2A

Discharge Voltage: *0.9V/Cell-1.6V/Cell; default: 1.1V/Cell*

End Current: *1%-100%; default: 50%*

Regenerative Mode:

OFF (default), To input, To channel

 **Note:** 1. The charger first discharges with constant current (CC) according to the user setting then turns to constant voltage (CV) when it reaches the discharge voltage. In the CV phase the current gradually falls, and the charger will terminate discharging when the current falls below the percentage of the configured discharge current.

2. Regenerative mode has three available settings: *OFF, To input, To channel*, see more details on Page38 [Important Notes](#)

➤ To Channel Setup

Switch to *To channel* mode on *Regenerative Mode* interface, click "**Set...**" to enter *To channel* setup interface, see details about setting on Page20 [To Channel Setup](#).



⇒ **NiZn Battery Discharge Advanced Setup**

Click “**Advanced**” to enter *NiZn DISCHARGE ADVANCED SETUP* interface, see details about setting on Page20 LiPo/LiIo/LiFe Battery Discharge Advanced Setup.

⇒ **NiZn Battery Discharge Safety Setup**

Click “**Safety**” to enter *DISCHARGE SAFETY SETUP* interface, see details about setting on Page21 LiPo/LiIo/LiFe Battery Discharge Safety Setup.

□ **NiZn Battery Cycle Setup**

Select *Program*→ *Cycle* to enter *Cycle* setup interface, see details about setting on Page21 LiPo/LiIo/LiFe Battery Cycle Setup.



4010DUO Parameters Setup

● 4010DUO Parameters Setup

Press **TAB/SYS** button for **2 seconds** on the initial interface to enter the *SYSTEM MENU* interface, setting and testing of the system parameters, storage and servo can be completed on this interface.

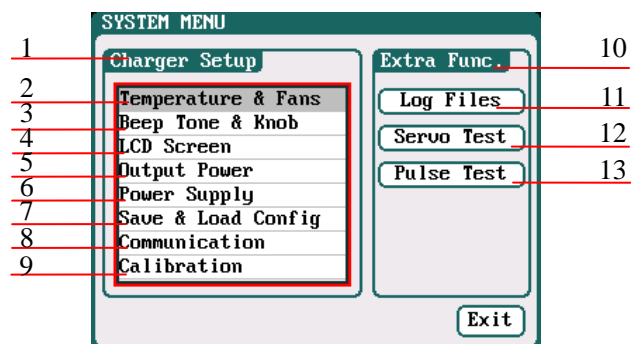

1: Charger Setup Menu

- | | |
|------------------------------------|---------------------------|
| 2: Temp. & Fans Setup | 3: Beep Tone & Knob Setup |
| 4: LCD Setup | 5: Output Power Setup |
| 6: Power Supply Setup | |
| 7: Save & Load Configuration Setup | |
| 8: Calibration | 9: Calibration |
| 10: Extra- Function | |
| 11: Log Files Manage | 12: Servo Test |
| 13: Pulse Test | |

◆ Charger Setup

After setting all parameters, click “**Save**” to save and return to the previous interface.

□ Temp. & Fans Setup

Select *SYSTEM MENU*→*Charger Setup*→*Temperature&Fans* to enter the setup interface, after setting click “**Save**” to save and return to the previous interface.

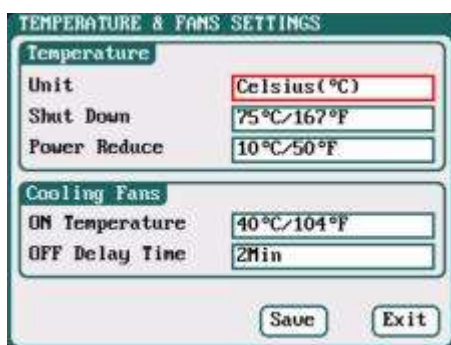

Temperature

Unit: *Celsius (default), Fahrenheit*
 Shut Down: *60 °C-75 °C; default: 75 °C*
 Power Reduce: *5 °C-20 °C; default: 10 °C*

Cooling Fans

ON Temperature: *30 °C-50 °C; default: 40 °C*
 OFF Delay Time: *0Min-10Min; default: 2Min*



Note: When the charger’s internal temperature reaches the *ON Temperature*, the fan will start automatically to dissipate heat, and adjust speed automatically depends on the temperature increasing or decreasing. When the temperature exceeds the *Power Reduce* temperature, the charger will stop increasing (temp. shown in orange) by reducing the highest power limit. When the temperature reaches *Shut Down* temperature, the charger will shut down. [When temp. >*Shut Down*-3, the temperature is shown flashing in red]. When the temperature is lower to the *ON Temperature*, the fan will keep running within the setting time of *OFF Delay Time*.

Beep Tone Setup

Select *SYSTEM MENU*→*Charger Setup*→*Beep Tone* to enter the setup interface.

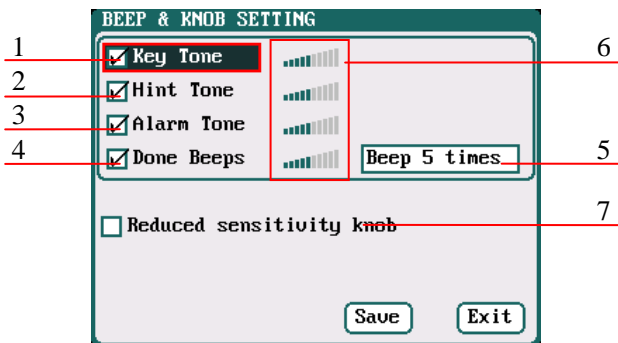

- 1: Key Tone
- 2: Hint Tone
- 3: Alarm Tone
- 4: Done Beeps
- 5: Volume adjustment display
Beep 5times (default)
Beep 30second
Beep 3minutes
Beep always
- 6: Program Done Beep Tones Selection
- 7: Reduced sensitivtv knob

 **Note:** Tick the appropriate tone, and then go to Volume adjustment bar to adjust the volume; If the beep tone is not ticked the corresponding volume adjustment shows inactive; *Done Beeps* have many styles available, in sequence number 5 above.

LCD Setup

Select *SYSTEM MENU*→*Charger Setup*→*LCD Screen* to enter the setup interface.

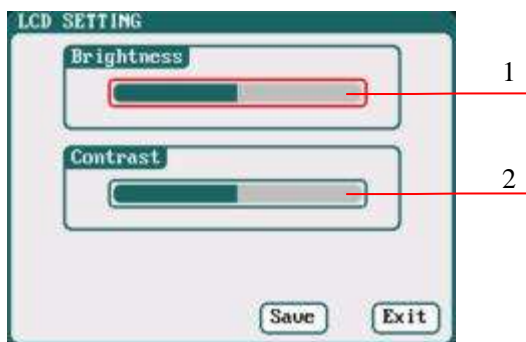

- 1: Brightness adjustment
- 2: Contrast adjustment

Output Power Setup

Select *SYSTEM MENU*→*Charger Setup*→*Output Power* to enter the setup interface.

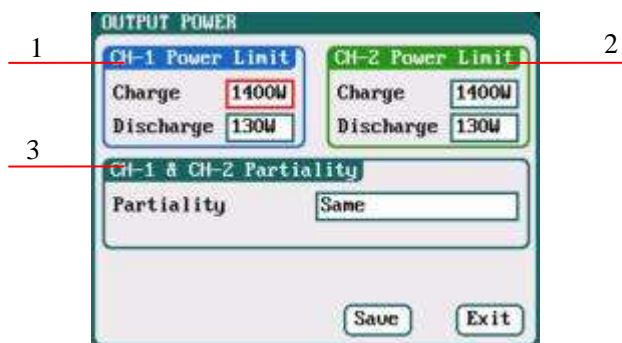

- 1/2: CH-1/CH-2 Output Power Setup
Charge: Maximum Power Limit for charge
5W-1400W; default: 1400W
Discharge: Maximum Power Limit for discharge
5W-130W; default: 130W
- 3: CH-1/CH-2 Channel Partiality Selection
Same (default), CH-1, CH-2

 **Note:** The maximum power limit for regenerative discharge is equal to the maximum power limit for charge.

When the input or output power of charger is limited, it will trigger the CH-1/CH-2 Channel Partiality.

When Partiality switches to *Same*, charger assigns the output power equally to two channels, switch to CH-1 or CH-2, the charger will give priority to the selected channel output, while the output power of other channel may be reduced to 50W (discharge for 5W).



❑ Power Supply Setup

Select *SYSTEM MENU*→*Charger Setup*→*Power Supply* to enter the setup interface.



- 1: DC Power
- 2: Battery Power

After selecting input source, click the "Setting..." followed by the option, enters the relevant power supply setting to set the parameters, after setting click "Save" to save and return to the previous interface.

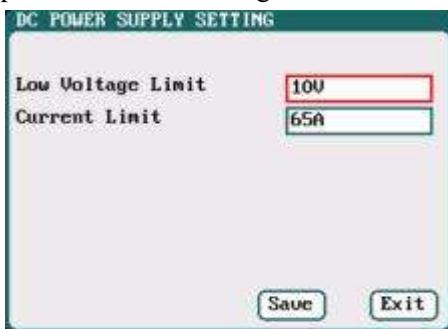

- Low Voltage Limit: 9V-48V; default: 10V
- Current Limit: 1A-65A; default: 65A

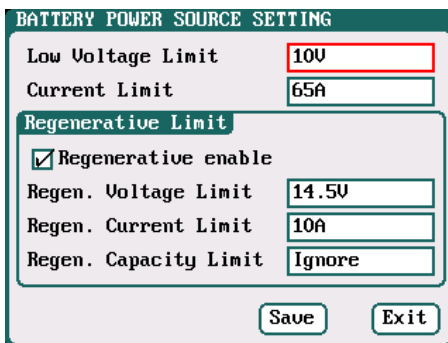

- Low Voltage Limit: 9V-48V; default: 10V
- Current Limit: 1A-65A; default: 65A
- Regen. Voltage Limit: 9V-48V; default: 14.5V
- Regen. Current Limit: 1A-65A; default: 10A
- Regen. Capacity Limit: Ignore (default)
100mAh-999900mAh

After ticking Regenerative enable, if run the regenerative discharge to input, the electrical discharged will be re-charged as the battery of input power.

❑ Save & Load Configuration Setup

Select **Save & Load Config** on *SYSTEM MENU* and enter the setup interface.

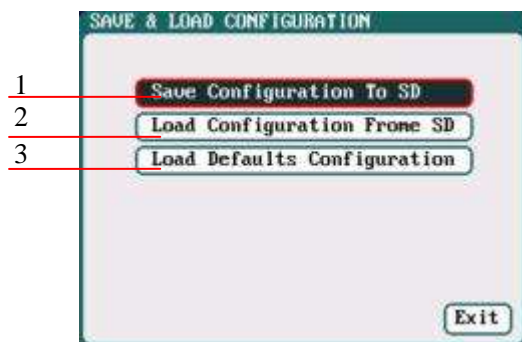

- 1: Save Configuration to SD card
- 2: Load Configuration from SD card
- 3: Load Defaults Configuration



- Note: 1. Users can save configuration to SD card and re-load via the SD card if needed.
- 2. After loading the configuration files, in addition to *Calibration Select*, it will cover all settings within the charger.



❑ Communication Settings

Select *SYSTEM MENU*→ *Charger Setup*→ *Communication* to enter the setup interface. See detailed information about communication port protocol in *iCharger Duo Protocol*.

Go to the website http://www.jun-si.com/UploadFiles/iCharger_MODBUS_Protocol.pdf to download.

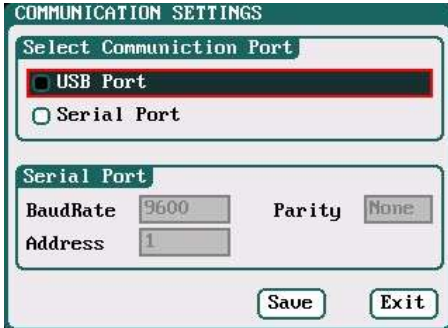

Select *Serial Port* as the communication way to activate, as below:

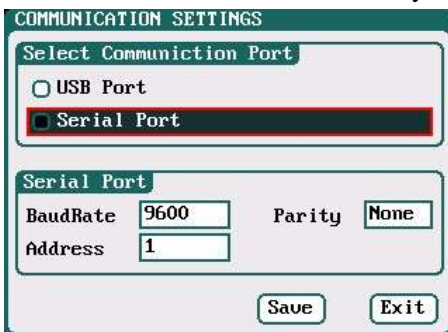

❑ Calibration

Select *SYSTEM MENU*→*Charger Setup*→*Calibration* to enter the setup interface. *User Calibration* may result in large data deviation, affecting normal use; so *User Calibration* is not suggested.

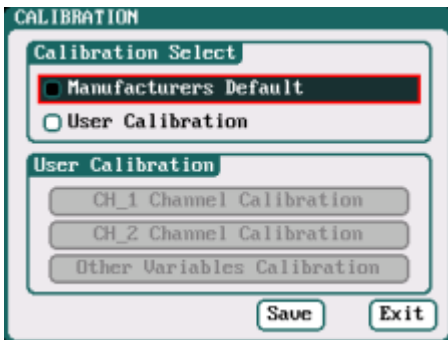

If users select *User Calibration*, the *User Calibration* option changes to active status; then select channel to enter the interface to calibrate.

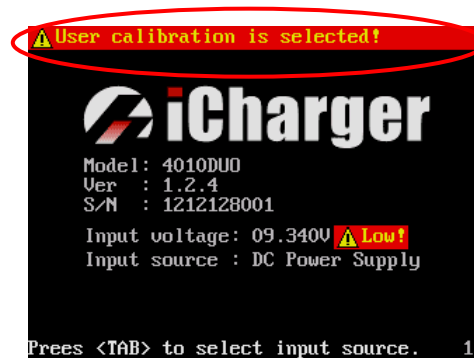
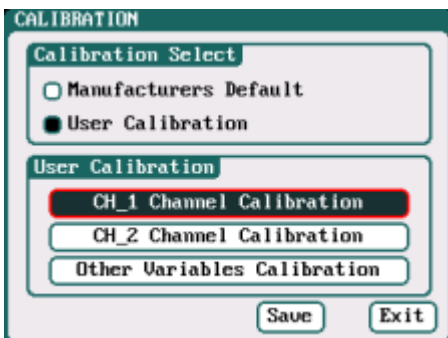



Note: User Calibration has *CH-X Channel Calibration* and *Other Variables Calibration* two options, users can calibrate charger for one channel alternatively. If user selects *User Calibration*, the corresponding message will appear in the interface after booting the charger, as shown in the right picture above.

Select *CH-1/2 Channel Calibration* to enter the channel calibration interface, Select *Other Variables Calibration* to enter the other variable calibration; after Calibration, click "Save" to save and return to the previous interface; click "Default" to load default value.

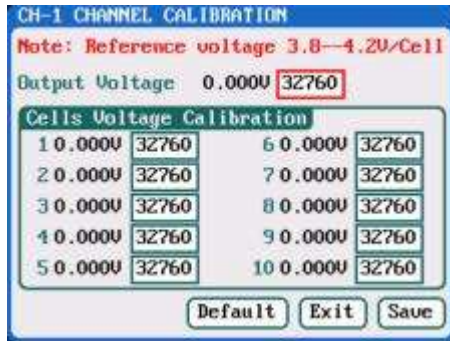

Channel Calibration



Other Variables Calibration

◆ Extra Function

□ Log Files Manage

Select *SYSTEM MENU*→*Extra Function*→*LOG FILES* to enter the manage interface.

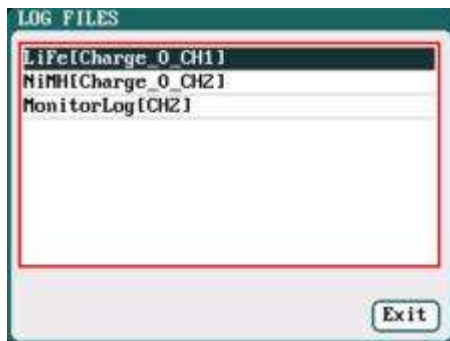

First select and click the .TXT files when managing log files, and the system will pop up the *LOG FILES OP* dialog box.



Log Files Manage Dialog

Transmission: transmission to PC

Delete: delete files

Delete All: delete all files

The charger must be connected with computer via USB when select *Transmission* and the client software must have identified to the charger.



Select *Delete* to pop up the *LOG FILE DELETE* dialog box, Select *Yes* to delete this file, select *No* to cancel.

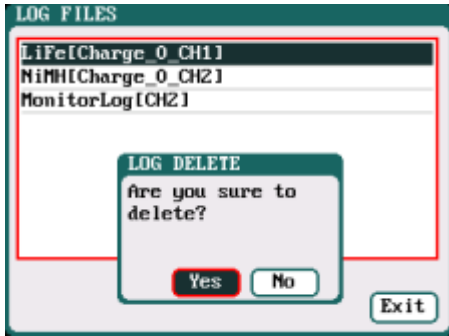

Servo Test

Select *SYSTEM MENU*→*Extra Function*→*SERVO TEST* to enter servo test interface; insert Servo into *J1* or *J2* port to test (only *J1* port supports Speed Test, *J2* can also be used as an external power source).



Type: Analog servo (1500us/50Hz)
Digital servo (1500us/333Hz)
Digital servo (760us/560Hz)
User: Pulse Center: 700us-1600us
Frame Rate: 40Hz-700Hz
45 ° Pulse Traveling: 100us-1000us

J2 can be used as an external power source: If *J1(5V/1A)* cannot provide the voltage needed for the servo, please connect through *J2* with external power source.

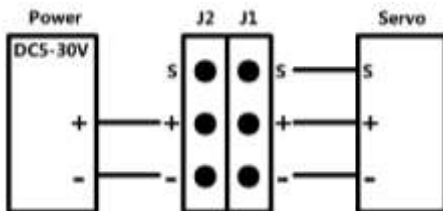

Select the test mode and go to the following corresponding interface.

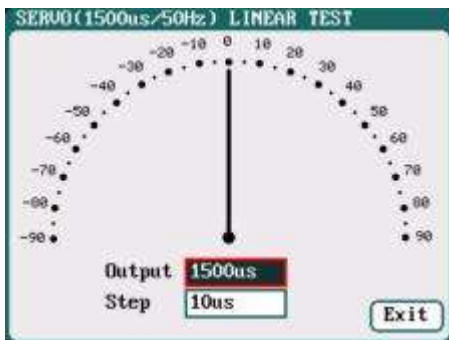

Liner Test: When turning the knob, the pointer deflects with the setting value of *Step*, and the servo responds accordingly.

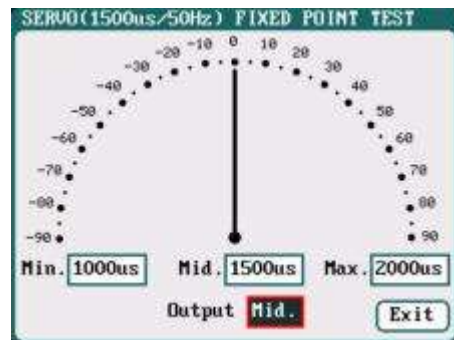

Fixed Point Test: When turning the knob, the pointer deflects among each setting value and the servo responds accordingly.

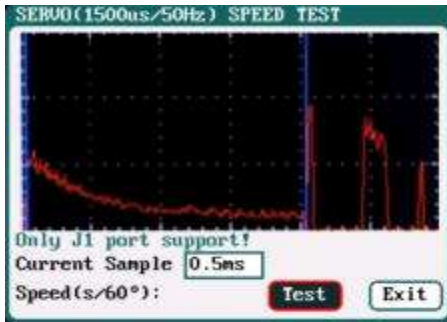

Speed Test: Click *Test* to read the test curves and test results.

Note: Current Sample, is the sampling value the AD for servo current, there are 300 sampling point in total. 300 * sampling rate = the entire sampling time, which must be larger than the servo speed, if not, it will fail to test the speed.

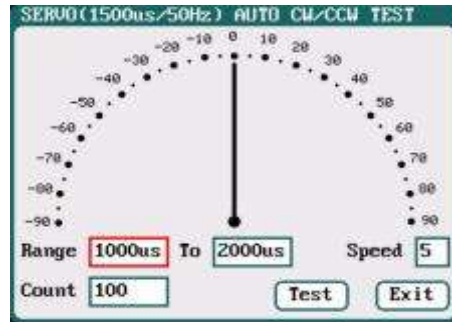

Auto CW/CCW Test: Click *Test* button then the pointer deflects the setting times at a set rate back and forth among each setting values, and the servo responds accordingly.

❑ Pulse Measurement

Select *SYSTEM MENU*→*Extra Function*→*Pulse Test* to enter the pulse test interface, only *J2* port supports the input signal of Pulse Measurement.

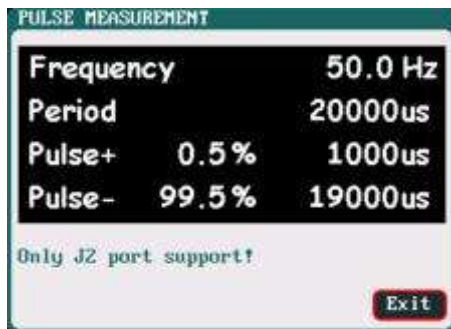

● USB & SD Card Use

4010DUO is the HID device of USB, supported by windows system directly, dispense with installing additional drivers. The USB icon will light up on the lower right corner of the screen when the 4010DUO connects with computer normally.

The SD icon will light up on the lower right corner of the screen when the SD card is inserted. If 4010DUO connects with the USB without running a program, the new added U disk can be found on the "My Computer" of the PC, and can operate the file. Log files are stored in the [X:\Junsi\iC4010DUO\Log](#) folder and config. files are stored in the [X:\Junsi\iC4010DUO\System](#) folder.

-  **Note:** 1. The file system of SD card must be FAT or FAT32.
- 2. Data in SD card needs to be backed up in case it is lost.

● Warranty & Service

- ① The product from the date of purchase enjoys free repair service within one year under normal conditions of use.
- ② Over the warranty, if replacement parts are needed the appropriate charge for components and repair will apply.
- ③ During the warranty period, any of the following circumstances will not enjoy free repairs:
 - 1) Failure to use in accordance with the requirements of the user manual.
 - 2) Failure or damage caused by the unauthorized user dismantling, appending or modifying the charger.
 - 3) Failure or damage due to natural disasters, bruises, collisions and incorrect supply voltages.



4010DUO Firmware Upgrades

① Go to the website <http://www.jun-si.com/UploadFiles/Upgrader.rar> to download above VER1.9 version upgrader zip file "Upgrader.rar", and extract to any disk on the PC.

② Open the extract directory [X:\upgrader\upgrader.exe](#), double click "upgrader.exe" to run the upgrader and enter program interface.



③ Click 'Open...' to open the firmware file. If there is no firmware file on the PC, click 'Download...' to open the download window, and find the corresponding device firmware of 4010DUO, click 'Download...' to download the firmware file to the PC.

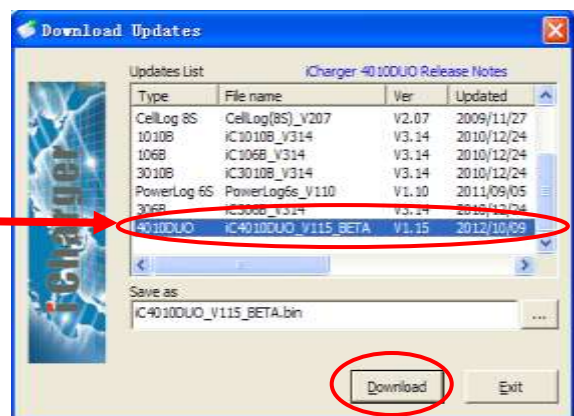
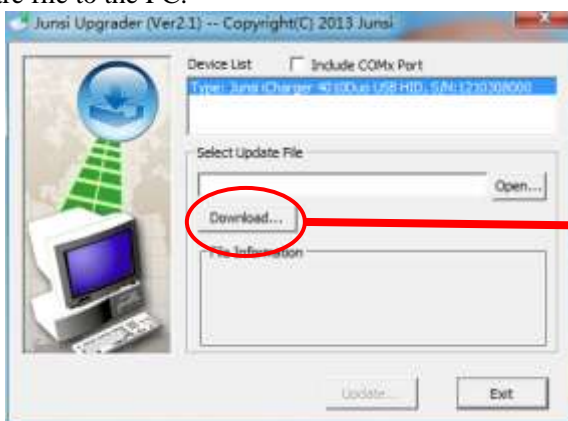

④ Connect 4010DUO charger to the PC via USB (windows system directly supports the device, dispensing with installing additional drivers). When the device information appears in Device List column, this shows the upgrade tool has identified the device.

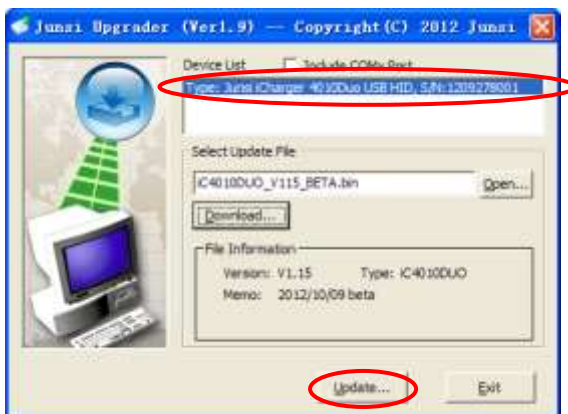



⑤ Click the iron 'Update...' on the lower right corner, then the upgrade progress bar will appear on the lower left corner, a tone sounds for upgrade completion when the upgrade progress bar has completed.



Note: 1. Upgrade failed in the case of not power outages, click 'Update...' to upgrade again.
2. Upgrade failed in the case of power outages, power up again and press knob, STATUS-2 and STOP/START-2 buttons at the same time and repeat the above steps to upgrade again.



Use Logview for 4010DUO

First, gratitude to the development team of Logview, more details please see <http://www.logview.info>.

● Communication Steps

- ① To install the Logview software, start the procedure of [X:\logview\LogViewInstaller.exe](#) (here X is the drive letter designator for the CD-ROM drive).
- ② Connect the iCharger with PC via USB port (make sure USB driver has been installed)
- ③ Start **LogView**
 - 1) Please choose language first;

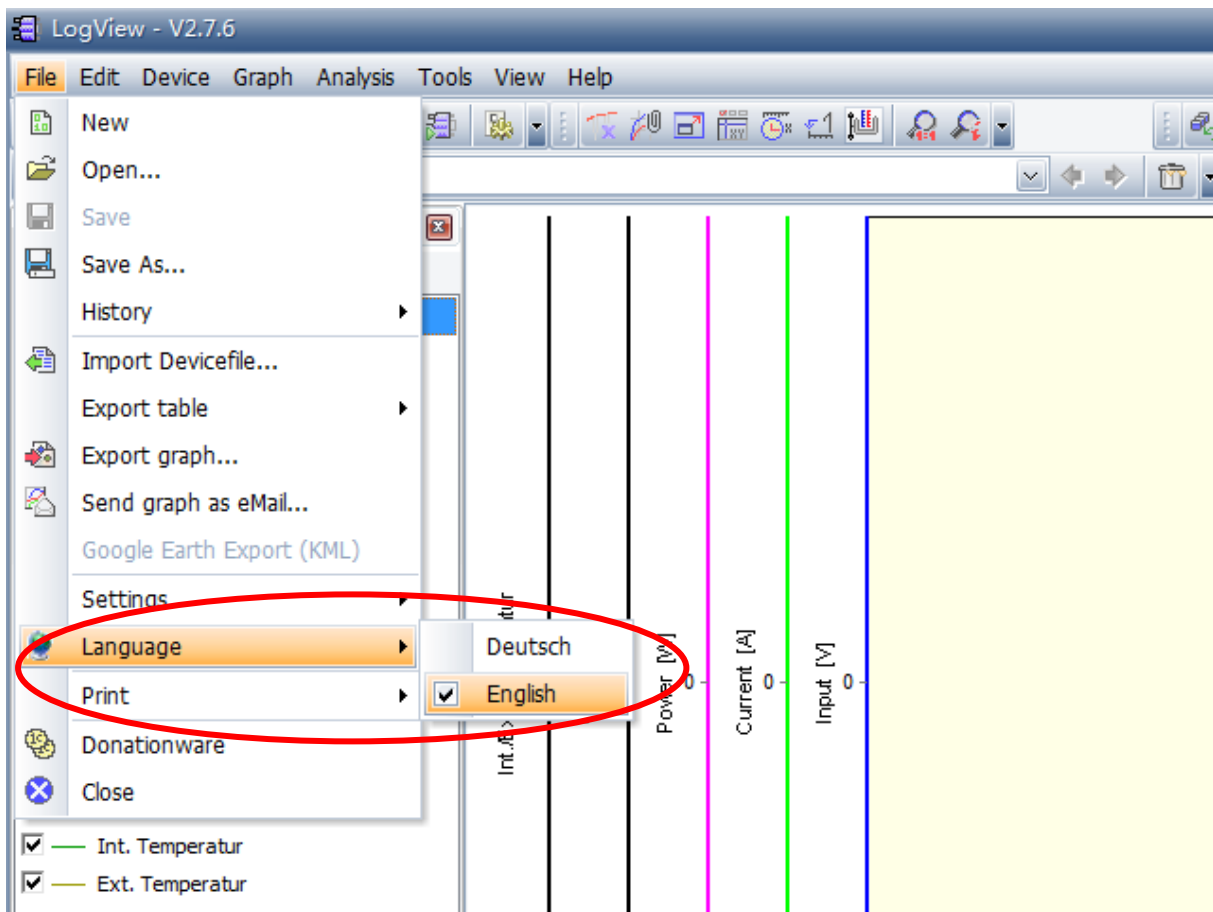



2) Choose **Device** → **Choose device and port**;

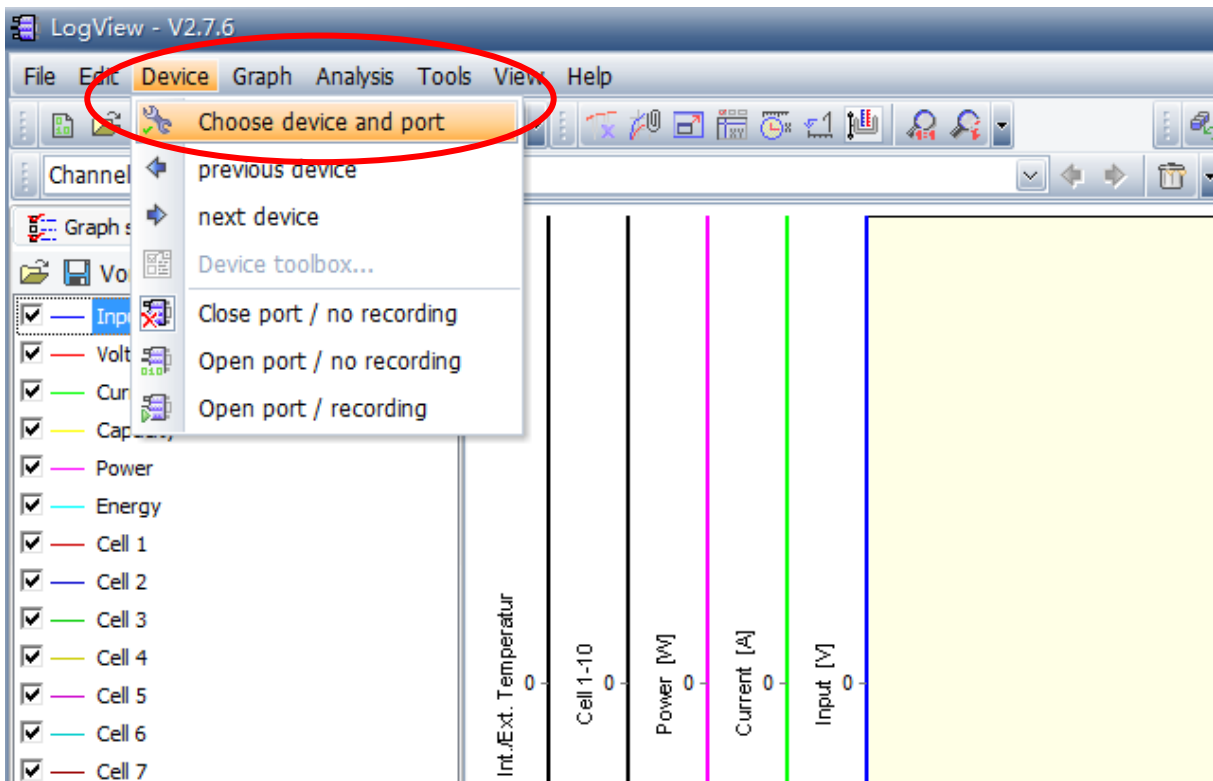

3) Choose **Junsi iCharger4010DUO** in the following options of **Device**, and then choose the correct communication Port;

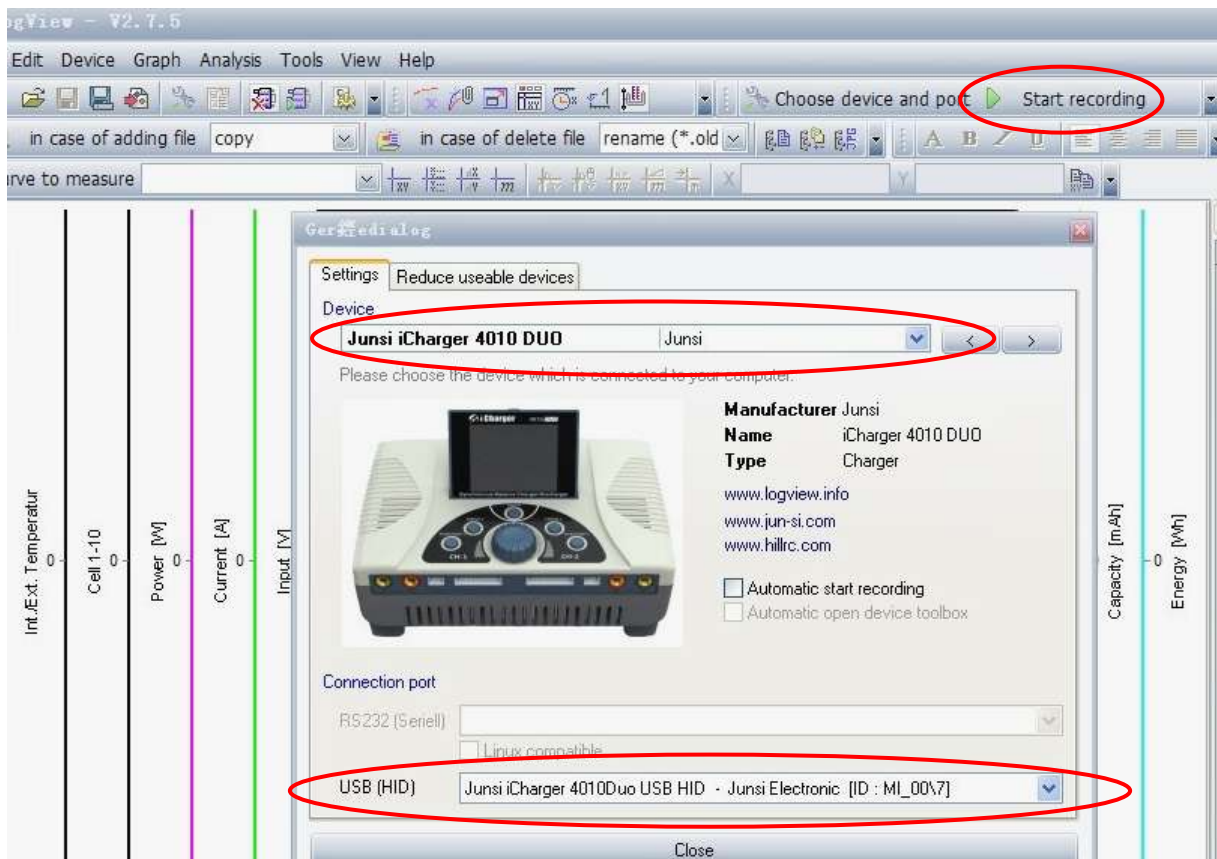

4) Start iCharger charge/discharge mode, then click **Start recording** to record data. See other functions of this software in "Help".



Important Notes

● The Charging Principle for Reflex Charge Mode

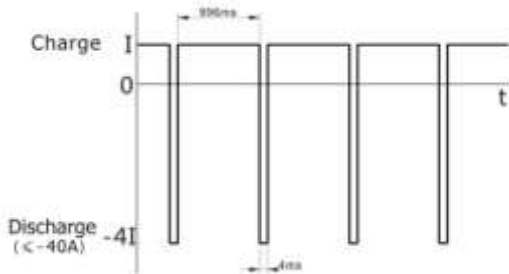

Note: Reflex charge mode only supports NiMH and Pb battery. It does not support lithium battery. Using reflex charge mode to charge battery can reduce effectively the heating of the battery. Go to the *MEMORY SETUP* → *Charge* → *Chg Mode* to select *Reflex* mode.

● Power Regenerative Mode

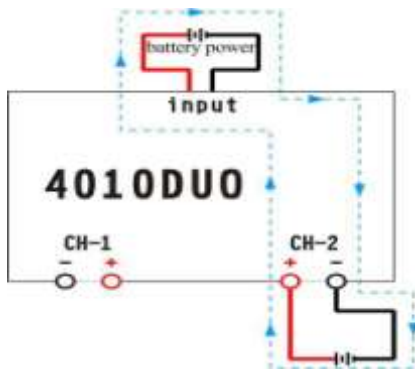

Note: Power Regenerative Mode: which is when the power supply for the charger acts as "battery power", the charger will regenerative charge for "battery power" during the process to discharge the battery. Go to *MEMORYSETUP* → *Discharge* → *Regenerative -Mode* to select *To input* mode.

● Channel Regenerative Mode

Channel Regenerative Mode is the feature for discharging from one channel to another channel, which supports resistor discharge, bulbs discharge, and charging battery.

◆ Resistance or Bulbs



- 1: Regenerative power
- 2: Regenerative voltage limit
- 3: Regenerative current limit

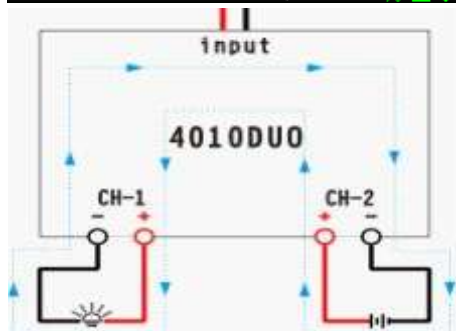

Resistance or bulbs as the load:

1. Connect the resistance or bulbs to any channel of the charger;
2. In another channel of the charger, *MEMORY SETUP* → *Discharge* → *Regenerative Mode* → *To channel*, to select *Resistance or bulbs*, then connect the battery for discharging to this channel, and start the discharge program to discharge the battery. Press STOP/START button to end the program during the period.



◆ Charging Battery

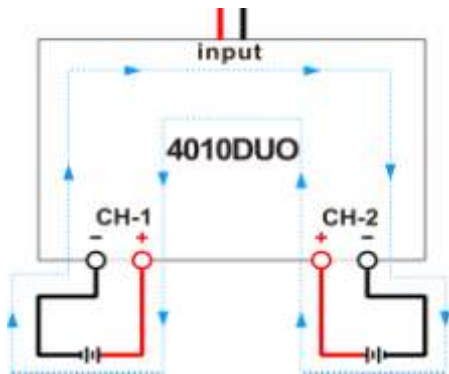

Battery as the load:

1. In any channel of the charger, *MEMORY SETUP* → *Discharge* → *Regenerative Mode* → *To channel*, to select Charging battery; then connect the battery for discharging to this channel, and start the discharge program, and this channel will be in discharging stand by status;
2. Connect the battery as the load to another channel of the charger, and start the charge program; the discharging channel is activated accordingly;
3. Press STOP/START button of any channel during the program running process to end the running status.

● Lithium Battery Extra Discharge Mode

You can expand the iCharger's discharge power capacity by connecting the external capacity resistance. You should pay special attention when expanding the discharge circuit. The balance port must be connected to the battery and the expanding capacity resistance R should be connected in series to the positive connection. (See the following diagram)

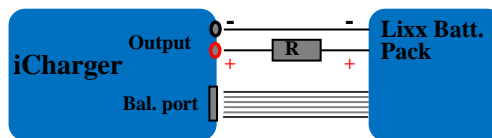

In this mode, the lithium battery discharges through the iCharger and R, $P = P_i + P_r$, (P_i is the charger's wasted power capacity; P_r is wasted power capacity by resistance). P_i is limited by the set charger's maximum discharge power capacity.

External capacity resistance's setting:

$$R = V_{bat} / I_{set};$$

$$P = V_{bat} * I_{set};$$

R: The value of the external capacity resistance

P: Rating capacity of the external capacity resistance

Iset: Discharge current

Vbat: Battery voltage

For example: discharge a pack of 20V lithium battery at 7A

$$R = 20V / 7A = 2.85\Omega$$

$$P = 20V \times 7A = 140W$$



Appendix

● Status Indication of Running Channel

Status	Status Indication	Status	Status indication
No display	No program, can select program to run	TRICK	Trickle charging status keeps a small current for a while after finishing charging NiCd or NiMH
STOPS	Stop status, press “stop” button to stop the running program	MONITO	Monitor status, only monitors the data
START	Start the program	FLOAT	Float charge, supports Pb battery
CHECK	Check status before running program	SYNCH.	Synchronous status, this channel runs with another channel synchronously
CHARGE	Charge status	LOAD	Load status, this channel works on the load control status of Channel regenerative
DISCHG	Discharge status	WAIT	Waiting status
PRE_C	Pre-charge, program will pre-charge when the cell voltage is too low	CY_DE	Cycle delay status
KEEP	Keep charging status, keep charging for a while after setting pre-charge	OVER!	Over status
BAL	Independent balance status. Only for balancing, not charging the Li-battery,	ERROR	Error status

● Status Indication of Channel Control

Status	Status Indication	Status	Status Indication
O.CV	Constant voltage status of output voltage	I.CC	Constant current status of input current
B.CV	Constant voltage status of Li-battery cells voltage	I.CP	Constant status of input power
O.CC	Constant current status of output current	O.C0	0 current regulation status
C.CP	Constant status of output power capacity	O.CP	Total power regulation status
C.TP	Temperature power reduce status	C.BL	Channel imbalance regulation status
I.CV	Constant status of input voltage	O.PC	Channel power containment regulation status



● Error Messages

Error NO.	Error Messages	Error Description
02XX	"Input over voltage"	The input voltage is too high
03XX	"Input under voltage"	The input voltage is too low
04XX	"Output over voltage"	The output voltage is too high
05XX	"Low battery voltage"	The voltage of the connected battery is too low
06XX	"High battery voltage"	The voltage of the connected battery is too high
07XX	"Output over current(+)"	Output over current (+)
08XX	"Output over current(-)"	Output over current (-)
09XX	"Input over current(+)"	Input over current (+)
10XX	"Input over current(-)"	Input over current (-)
11XX	"The internal temperature is too high"	The internal temperature is too high
12XX	"The internal temperature is too low"	The internal temperature is too low
13XX	"Connection check error"	Connection check error
14XX	"CH1 & CH2 common-negative connection prohibited"	Common-negative connected to CH1&CH2 is prohibited
15XX	"Battery polarity reversed!"	Battery has been connected with polarity reversed.
16XX	"Internal control error"	Internal control checking error
17XX	"Exceed safe time limit"	Safe time limit is exceeded
18XX	"Exceed safe capacity limit"	Safe capacity limit is exceeded
19XX	"Exceed safe temperature range"	Safe temperature range is exceeded
20XX	"Output connection broken"	Output connection is broken
21XX	"Balance port connection error"	Balance port has a connection error
22XX	"Low cell voltage detected on balance port"	Low cell voltage is detected on balance port
23XX	"High cell voltage detected on balance port"	High cell voltage is detected on balance port
24XX	"Voltage match error. Balance port sum is lower than output."	Voltage matched error, the voltage of the balance port sum is lower than the output one
25XX	"Voltage match error. Balance port sum is higher than output."	Voltage matched error, the voltage of balance port sum is higher than the output one
26XX	"Number of cells doesn't match the setting"	Number of cells connected doesn't match the setting
27XX	"Number of cells setting appears low"	Number of cells setting appears low



28XX	"Number of cells setting appears high"	Number of cells setting appears high
29XX	"Balance not needed, Remove connection from balance port"	Balance port error, Ni-, Pb does not need balance port, but voltage of balance port is detected
30XX	"Balance required!"	Balance port is unplugged
31XX	"Auto detect the number of cells failed, please connect balance or set cells"	Check connection or balance port
32XX	"AD watchdog error"	AD watchdog error
33XX	"Synchronous mode: Channel outputs imbalance"	Channel outputs are imbalance in Synchronous mode
34XX	"This channel is needed to access the resistor or bulb load"	This regenerative channel is needed to access the resistor or bulb load
35XX	"The other channel is occupied"	The other channel is occupied