

# Extra 330 ARF

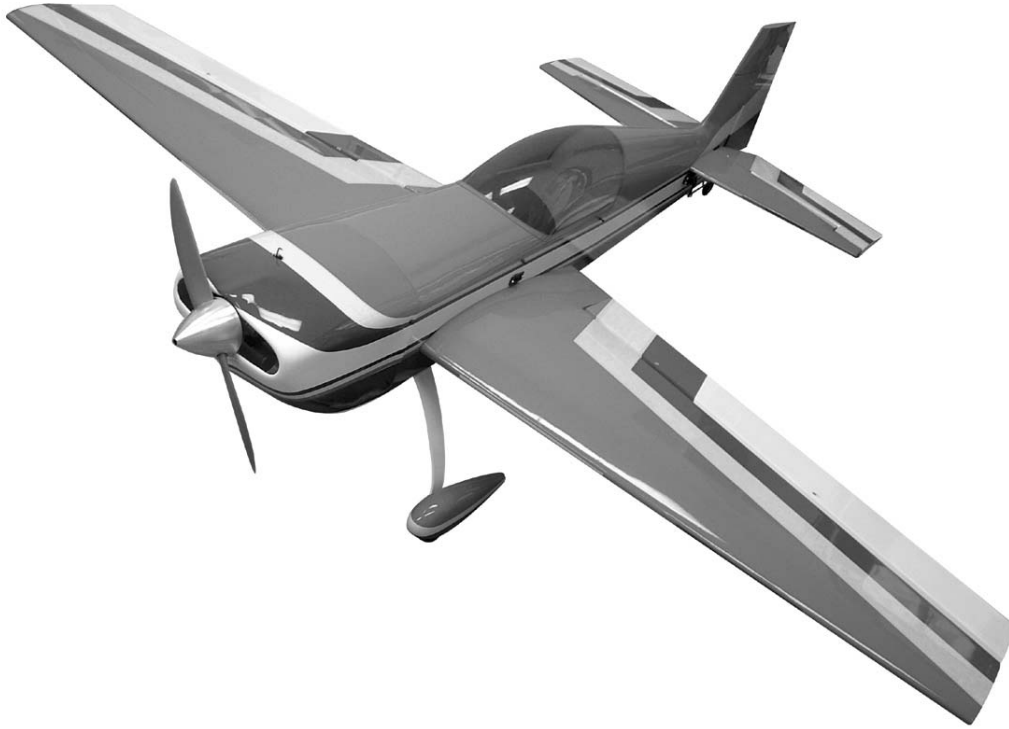

## WARNING

A radio-controlled model is not a toy and is not intended for persons under 16 years old. Keep this kit out of the reach of younger children, as it contains parts that could be dangerous. A radio-controlled model is capable of causing serious bodily injury and property damage. It is the buyer's responsibility to assemble this aircraft correctly and to properly install the motor, radio, and all other equipment. Test and fly the finished model only in the presence and with the assistance of another experienced R/C flyer. The model must always be operated and flown using great care and common sense, as well as in accordance with the Safety Code of the Academy of Model Aeronautics (5151 Memorial Drive, Muncie, IN 47302, 1-800-435-9262). We suggest you join the AMA and become properly insured prior to flying this model. Also, consult with the AMA or your local hobby dealer to find an experienced instructor in your area. Per the Federal Communications Commission, you are required to use only those radio frequencies specified "for Model Aircraft."

## LIMITED WARRANTY

Carl Goldberg Products, Ltd. has inspected and certified the components of this aircraft. The company urges the buyer to perform his own inspection, prior to assembly, and to immediately request a replacement of any parts he believes to be defective for their intended use. The company warrants replacement of any such components, provided the buyer requests such replacement within a period of 90 days from the date of purchase and provided the defective part is returned, if so requested by the company.

No other warranty, expressed or implied, is made by the company with respect to this kit. The buyer acknowledges and understands that it is his responsibility to carefully assemble the finished flying model airplane and to fly it safely. The buyer hereby assumes full responsibility for the risk and all liability for personal or property damage or injury arising out of the buyer's use of the components of this kit.

## CARL GOLDBERG PRODUCTS, LTD.

P.O. Box 818 Oakwood GA 30566 Phone #678-450-0085 Fax # 770-532-2163 [www.carlgoldbergproducts.com](http://www.carlgoldbergproducts.com)

Congratulations on your purchase of the **Extra 330ARF**. This is a very unique dual-purpose aircraft, capable of flying any FAI pattern sequence with ease, while exhibiting remarkable 3-D capabilities. Every effort has been made to produce a lightweight, straight, easy to assemble aircraft. Because of its oversize control surfaces which are double beveled to allow for extreme throws, great care must be taken in the set-up and flying of this airplane. Quality hardware components have been provided to allow for 3D set-up while maintaining adequate mechanical advantage to eliminate flutter. It is your responsibility as an advanced pilot to fly the aircraft in an intelligent manner. **THROTTLE MANAGEMENT IS A MUST!!!!!!!** Carl Goldberg Products has flown the **Extra 330ARF** through a very rigorous flight-testing schedule and have stressed the airframe beyond all practical parameters without a single failure. Carl Goldberg Products will NOT warrant the **Extra 330ARF** against flutter due to improper set-up or excessive speed maneuvers. Having said that, we believe you will find the **Extra 330ARF** to be one of the most responsive, in-the-grove aircraft on the market. Just remember to use common sense when flying this high performance machine.

We are very proud of the construction of the **Extra 330ARF** and all of our other ARF aircraft. Each aircraft is jig built to insure a straight true airframe. Every effort is made to build as light an aircraft as possible. As with any professional builder, glue is used sparingly. **Please take a moment during assembly and run a bead of CA or aliphatic resin into the high stress joints that you can reach such as the landing gear plate, servo mounting trays, wing hold down blocks, etc.** Also, during the course of shipping from the manufacturer to our facility in the United States, it is not uncommon for the aircraft to experience several changes in climate. This may cause the iron-on covering to develop wrinkles. This is not a fault of the manufacturer. Please take a few minutes with your heating iron and heat gun to iron down the seams and re-shrink the covering where needed. The results will be a beautiful aircraft with a breathtaking finish that you will be proud to display at your flying club.

Before beginning assembly of your **Extra 330ARF**, we highly recommend that you study this manual in its entirety. You should begin planning your radio installation based on your choice of engine and equipment from the beginning.

Because the **Extra 330ARF** is intended for those with some degree of modeling experience, every minute detail will not be covered. This is not a basic trainer. Assembly of this aircraft will be easy for the experienced modeler, and by following the instructions within this manual and using the skills you've gained during your modeling career you will be able to produce a first class aircraft.

## Building supplies needed

Hobby knife w/#11 blades  
Thin CA  
Medium CA  
Canopy glue  
30 minute epoxy  
Thread lock  
Diagonal wire cutters  
Pliers  
Assorted drill bits  
Various sized screwdrivers( both Phillips and standard head)  
Tape measure  
Dry-erase marker  
Paper towels  
Rubbing alcohol  
Electrical tape  
4-40 Tap & Die Set  
3/32, 7/64, 9/64 & 3mm Allen wrench  
Wax Paper

### Note:

**Thread lock must be used where ever any machine bolts are going into any type of nuts. If you do not use thread lock the bolts could become loose and fall out in flight.**

## **ADHESIVES & GLUING TECHNIQUES**

CA adhesives are specially formulated to firmly glue the plywood, hardwood, and balsa used in your model and to withstand the vibration and stresses of high performance flight. However, there are times, such as when you are installing the stabilizer and fin on the fuselage and want more set-up time for careful alignment and positioning, then you should use epoxy. Occasionally, you also will want to use thin CA, which "wicks" into the surrounding areas. Aliphatic resin glue or similar water-based glues can also be used, but they will add to the assembly time because they dry so much more slowly than CA glue. Remember, when ever using any CA, you must be careful to read instructions thoroughly, as you will have only seconds for positioning of parts. Be sure to trial fit parts together before gluing. Also, never use watery THIN type CA glue for gluing plywood and hardwood parts. Thin CA's do not adequately bond these areas.

### **CAUTION**

Some people may experience an allergic reaction when exposed to fumes from CA glue or epoxy. As with paints, thinners, and solvents, it is always important to use glues only where there is adequate ventilation to carry fumes away. A fan is recommended. Also, special care must be taken when using CA, as it will bond skin as well as other surfaces. Before using any CA, carefully read all label precautions. When using CA, protective eye-wear and care in keeping the glue away from the face is highly recommended. If CA does happen to get into the eye, hold lid open and flush with water only. Seek immediate medical attention.

### **PREPARING FOR ASSEMBLY**

You will need a work area of approximately 24 x 48" which has been covered to protect it from adhesive, as well as cuts and other damage. Many people cover their work area with a sheet of dry wall (sheet rock) and/or waxed paper to prevent CA Glue and Epoxy from ruining the work surface.

### **CONSTRUCTION TIPS**

**IMPORTANT: ALWAYS READ A FEW STEPS AHEAD.** This will alert you to coming instructions and will help you plan accordingly.

Using the Parts Identification section, familiarize yourself with the various items included in your kit box.

### **COVERING**

The **Extra 330** ARF is covered in a premium polyester film chosen by many of the world's top flyers for its beauty, toughness, and ease of application and repair. It is not uncommon for ARF's to develop a few wrinkles in transit. If this is true of your model, the situation is easily corrected. Before you begin putting the pieces together, run around the edge of the seams first then over the surface of each section with an iron (either specially designed for airplane use or the more cumbersome household iron). Apply the heat (set at about 350° F), following along with a soft cloth and pressing down on the covering as you go around. This will more firmly set the covering adhesive into the wood and keep your aircraft covering tight and smooth in the future. Once you have ironed the seams stay away from them with the heat or the covering will slide when you try to shrink the middle. If this happens the wrinkles will not come out of the covering.

## **ITEMS NEEDED TO COMPLETE THIS AIRCRAFT**

- 1 RADIO GUIDANCE SYSTEM (6 CHANNEL MINIMUM REQUIRED WITH 8 SERVOS)
- 2 24" ELEVATOR SERVO EXTENSION WIRES
- 2 24" Y-HARNESSES
- 1 CA ACCELERATOR
- 1 2 OZ. BOTTLE CA MEDIUM GLUE
- 1 1/2 OZ. BOTTLE CA THIN GLUE
- 1 30 MINUET EPOXY
- 1 1/2" FOAM RUBBER
- 1 3" SPINNER

### **OPTIONAL:**

- 1 1/4 SCALE PILOT FIGURE

**NOTE: The Extra 330 ARF covering closely matches Bright Yellow (#872), Flame Red (#883), Deep Blue (#873) and White (#870) Oracover.**

# WING ASSEMBLY

## AILERON INSTALLATION

1.  Collect the following parts:

- (1) Left wing
- (1) Right wing
- (1) Left aileron
- (1) Right aileron
- (10) hinges



2.  Locate the pre-drilled aileron hinge holes in both wing halves. Using a 1/4" drill, drill each hole 1/8" deep. This will allow the center of the hinge to be inserted half way into each of the surfaces.  
 Repeat this process with the ailerons, making sure all hinges insert half way.

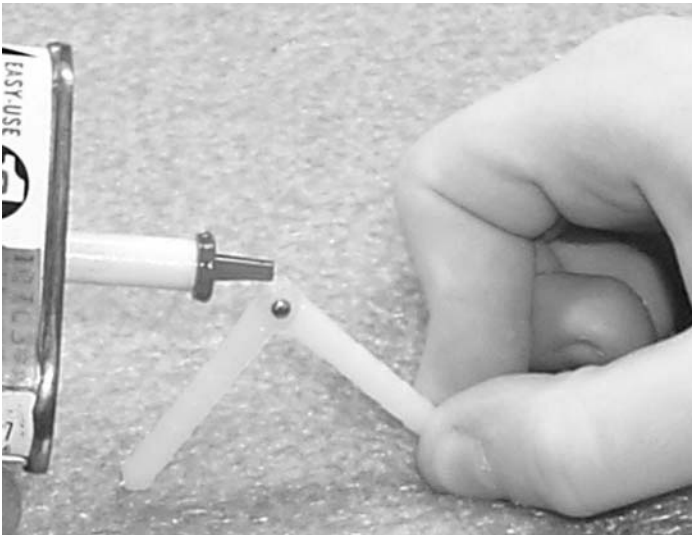

3.  Place 1 drop of oil on each of the hinges at the center. This is to keep the hinges loose and prevent epoxy from sticking at the joint.

**Caution: Do not get any oil on the length of the hinge or it will not glue into the surface.**

4.  Select the aileron for the wing half on which you are working.  
 Mix up a liberal amount of 30 minute epoxy.  
 Working with 1 hinge at a time, place a dab of epoxy and insert the hinge half way into one of the aileron holes.  
 Repeat for each of the other hinges for that aileron.
5.  Working quickly, place some epoxy on the second half of each hinge and insert the aileron into the wing.  
 Slide the aileron toward the wing until no gap remains between the aileron and the wing.  
 When satisfied with the alignment, flex the aileron up and down to confirm that the hinges are working freely. remove any excess epoxy.  
 Apply a few strips of masking tape to keep the pieces in place.  
 Allow to dry before flexing the aileron.
6.  Repeat the above steps for the other half of the wing.

## AILERON SERVO INSTALLATION

1.  Collect the following parts:

- (1) Left wing
- (1) Right wing
- (4) Servos
- (2) 24" "Y" Harness

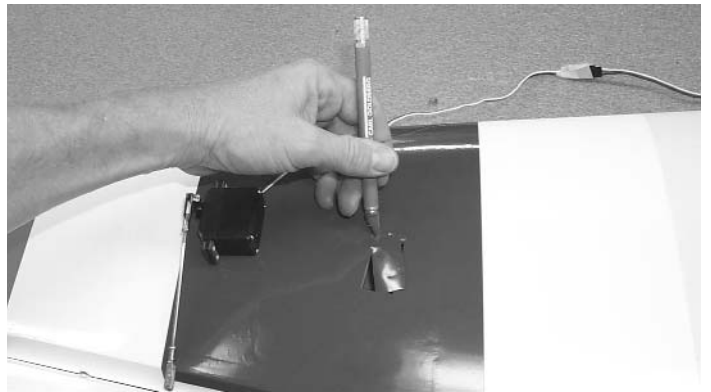

2.  Locate the two servo holes in the bottom of wing.  
 Carefully cut the covering over the servo holes.

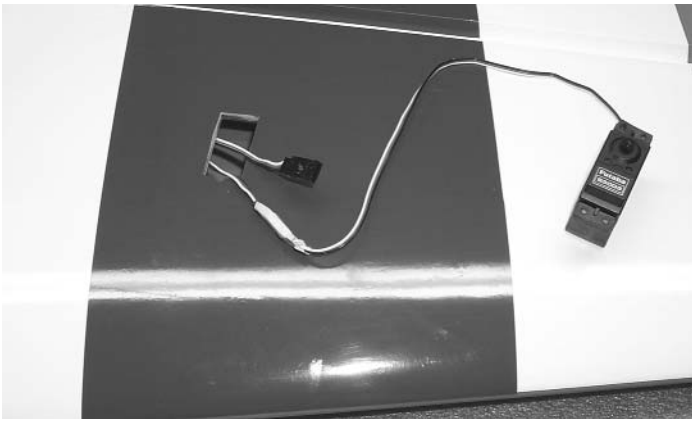

3.  Attach the 24" "Y" harness to one of the servos.

**IMPORTANT!** To ensure that any connections located inside the wing will not come loose, either when the wires are pulled, or during flying, **always tape them securely together with electrical tape.**



4.  Starting from the outer servo hole, insert the "Y" harness and the servo wire into the servo hole.
- Allow the wire to fall straight down through the wing till it exits the root rib.

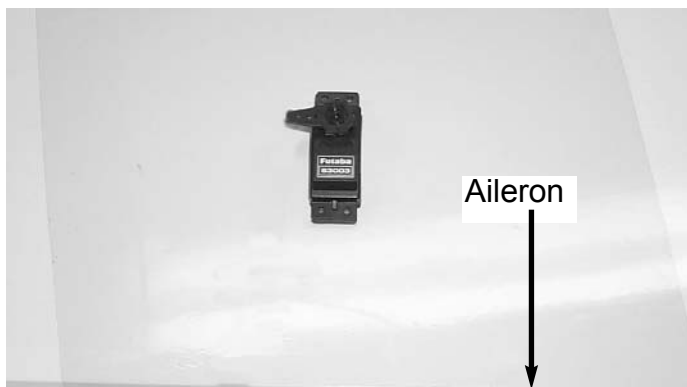

5.  Tape the end of the plug to the root rib.
- Mount the outer aileron servo to the wing.

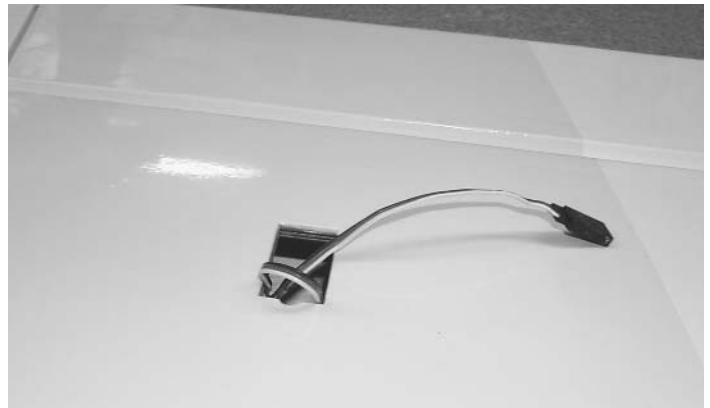

6.  Pull the second half of the "Y" harness out the inner servo hole.
- Plug the second aileron servo into the wire harness. **Always tape them securely together with electrical tape.**
- Install the second aileron servo into the wing.

### AILERON CONTROL HORN INSTALLATION

1.  Collect the following items
- (8) 4-40 Metal Clevis
  - (8) 4-40 Hex Nut
  - (4) 4-40 x 3-3/4" Double Threaded Wire
  - (4) 6-32 x 2" Bolt
  - (4) 6-32 Hex Nut
  - (4) #6 Washer
  - (4) 6-32 Adjustable Horn Bracket
  - (4) Clevis Clips

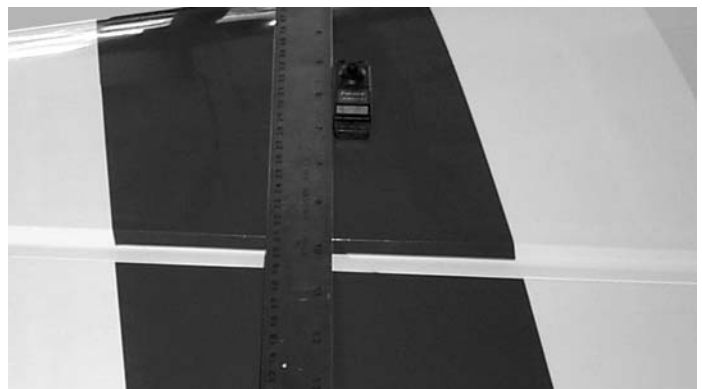

2.  With the aileron servo in place, make a mark on the aileron at a 90° degree angle to the trailing edge and in line with the servo.

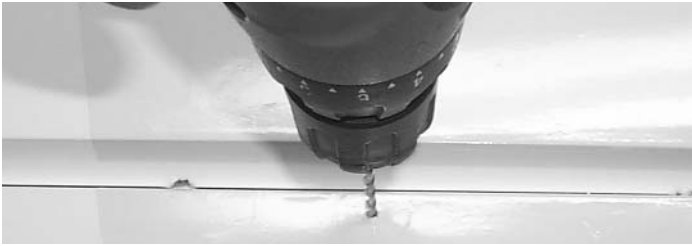

3.  Position the control horn bolt so that it is 1/2" back from the hinge line on the mark that you just made.
4.  Using a 9/64" drill bit, make a hole in the aileron through to the top side.

**HINT: Drill the hole from the bottom half way. Then measure and mark the top of the aileron and drill down to the hole from the top of the aileron.**

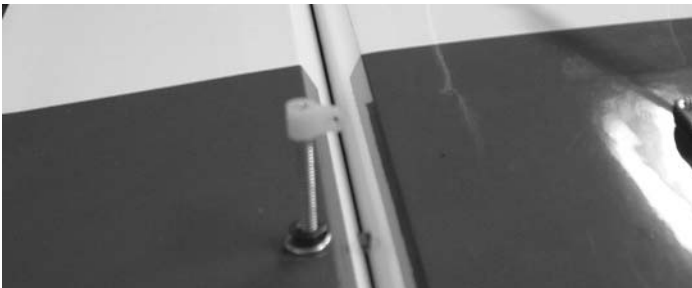

5.  Insert the 6-32 x 2" screw from the top through the aileron.
- Place the #6 washer and the 6-32 hex nut on the bolt and tighten. Make sure that you use thread lock on the bolt and nut.
- Screw the adjustable horn bracket on to the bolt.

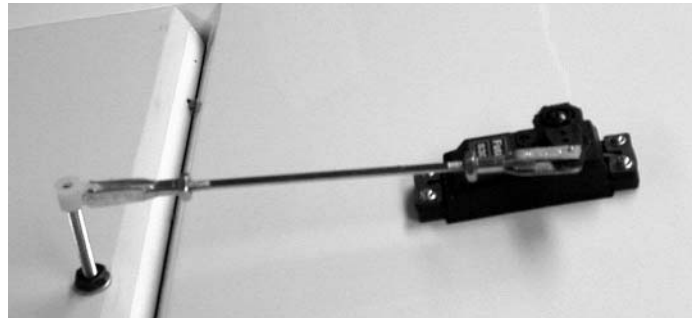

6.  Thread on to each end of the 4-40 x 3-3/4" pushrod a hex nut and a metal clevis.
- Install the metal clevis onto the horn bracket and the servo arm.
- Install a clevis clip on to each clevis and tighten the hex nut against the clevis.
- Repeat the above steps for the second aileron servo.
7.  Repeat steps 2 thru 6 for the second wing half.

**Caution:**

**Make sure each snap link is fully closed and a clip is installed before and after each flight.**

**Mounting Stab**

**Collect the following parts:**

- (1) Left Stabilizer
- (1) Right Stabilizer
- (1) 1/2" x 16-1/4" Stabilizer Tube
- (2) 4-40 x 1/2 bolts

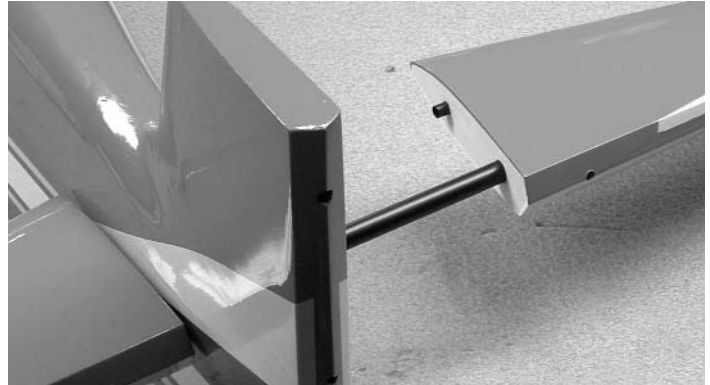

**Note:**

**Now is the time to decide if you want to glue the stabilizer to the tubes and the fuselage, or if you wish to have removable stabilizers.**

1.  Slide the small stabilizer tube into one side of the stab. Then slide the assembly into the hole in the fuselage till the stab is flush against the fuse. (The side of the stab with the hole is the bottom of the stabilizer). Slide the second stab onto the tube sticking out the other side of the fuselage. Squeeze both stab pieces together firmly on to the fuselage.

- Check that the stabilizer is level with the wing. Shim the tube in the fuselage up or down if necessary. Do not go any farther till the stab is level to the wing.

**The Stabilizer can be mounted to the fuselage two ways:**

**Removable Stabilizer**

1.  Using 4-40 bolt, drill and tap the stabilizer tube at the hole location. This method will allow you to remove the stab as needed. **CAUTION:** You must watch the bolt holes for fatigue and drill another hole by rotating the tube when this happens.

## Gluing Stabilizer:

1. Using a pencil, make an outline where the stabilizer rest against the fuselage.
2. Remove both stabilizers from the tubes.
3. Remove the tubing from the fuselage.
4. Lightly sand the tubing using 220 sand paper.
5. Remove the covering from the fuselage inside the outline that you made.
6. Mix up epoxy and slide the stabilizer assembly together again, allow to dry.

## HINGING THE ELEVATORS

1.  Collect the following items:
  - (2) Elevators
  - (6) Hinges



2.  cut two barbs off of two hinges on one side only.



3.  Insert the shortened hinge into the hinge hole closes to the fuselage.
  - Make sure that the hinge fits completely into the stabilizer. Keep cutting the hinge till it fits.

4.  Take the elevators and the stabilizers and just like you did for the ailerons pre-drill each of then hinge holes.
  - Place a drop of oil on each of the hinges.
5.  Mix up some 30 minute epoxy and glue each of the elevators to the stabilizers.
  - Tape the elevators to the stabilizers till dry.

## ELEVATOR & SERVOS

1.  Collect the following items:
  - (2) Servos
  - (2) 24" Servo Extensions
  - (2) 4-40 x 3-1/2" Double Threaded Pushrod
  - (4) 4-40 Hex Nuts
  - (4) 4-40 Metal Clevis
  - (4) Clevis Clips
  - (2) 6-32 x 2-1/2 " Flat Head Bolt
  - (2) #6 Washer
  - (2) 6-32 Hex Nut
  - (2) 6-32 Horn Bracket

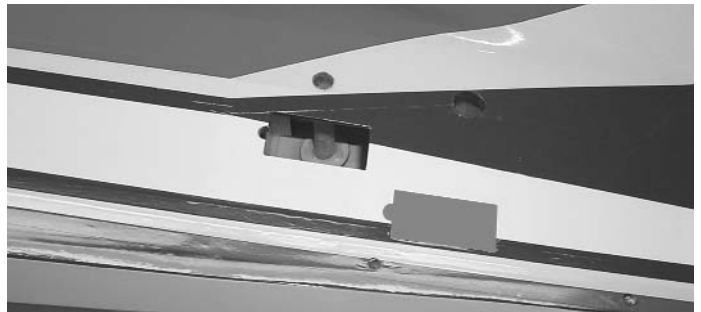

### Note:

**We have included a rudder servo hole in the fuselage just behind and below the elevator servo hole. If you choose to install a large engine or just want better rudder control, then install your rudder servo here(There is a hole on both side of the fuselage for push-pull system). More weight in the nose will be required for this system.**

1. Remove the covering over the elevator servo holes on both sides of the fuselage.



2.  Plug the 24" extensions into the elevator servos.
  - Make sure that the extensions plugs are taped to the servos.
3.  Screw the elevator servos into the fuselage.



4.  Position the control horn bolt so that it is 1/2" back from the hinge line and 3/4" from the end of the elevator.
5.  Using a 9/64" drill bit, make a hole in the elevator through to the top side.

**HINT: Drill the hole from the bottom half way. Then measure and mark the top of the aileron and drill down to the hole from the top of the aileron.**

6.  Insert the 6-32 x 2" screw from the top through the elevator.
  - Place the #6 washer and the 6-32 hex nut on the bolt and tighten. Make sure that you use thread lock on the bolt and nut.
  - Screw the adjustable horn bracket on to the bolt.



6.  Thread on to each end of the 4-40 x 3-1/2" pushrod a hex nut and a metal clevis.
  - Install the metal clevis onto the horn bracket and the servo arm. tighten the hex nut against the metal clevis.
  - Install a clevis clip on to each clevis.
  - Repeat the above steps for the second elevator.

**Caution:**  
**Make sure each metal clevis is fully closed and a clip is installed before and after each flight.**

**RUDDER & TAILWHEEL**

1.  Collect the following items:
  - (1) 6-32 x 3" All threaded rod
  - (4) Small White Adjustable Horn
  - (2) 6-32 Hex Nut
  - (2) #6 Flat Washer
  - (1) Rudder
  - (3) Hinges
2.  Install the hinges into the rudder and glue the rudder in place using the same hinging method used for the elevator and ailerons.



3.  Position the control horn bolt so that it is 1/2" back from hinge line and 1/2" up from the bottom of the rudder.
  - Using a 9/64" drill bit, make a hole in the rudder.
4.  Center the 6-32 x 3" threaded rod in the hole.
  - Using thread lock place first the #6 washer then the 6-32 Hex nut on each side of the rudder.





5.  Thread the 2 white adjustable horn brackets on the rod.
- Do this on both sides of the bolt.

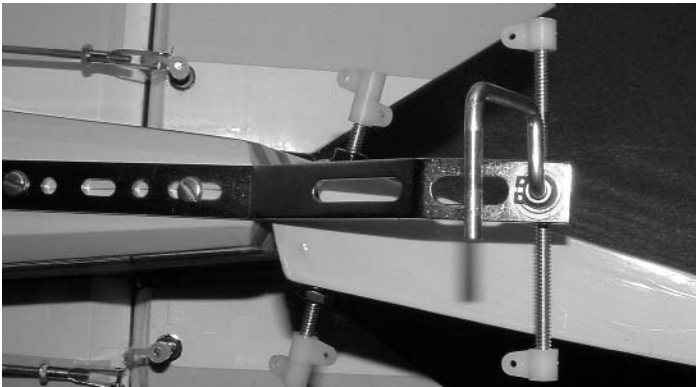

6.  Thread the 6-32 x 3" threaded rod half way into the brass nob that is on top of the axle on the tailwheel bracket.
- Place on the each end of the threaded rod a white horn bracket.
- Mark the center of the fuselage and place the tail wheel bracket on the center line.
- Place the first bend of the bracket where it bends away from the fuselage just in front of the rudder hinge line.
7.  Drill a 3/32" hole in the first and last mounting holes in the bracket
- Mount the tailwheel bracket using 2 #6 x 1/2" sheet metal screws.

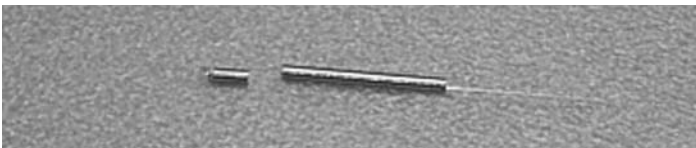

8.  Remove from the tailwheel springs approximately 1/2" from the other side of the long wire.
- On the side of the spring that you just cut off, bend 2 or 3 coils of the spring out so that they can hook through the horn bracket.

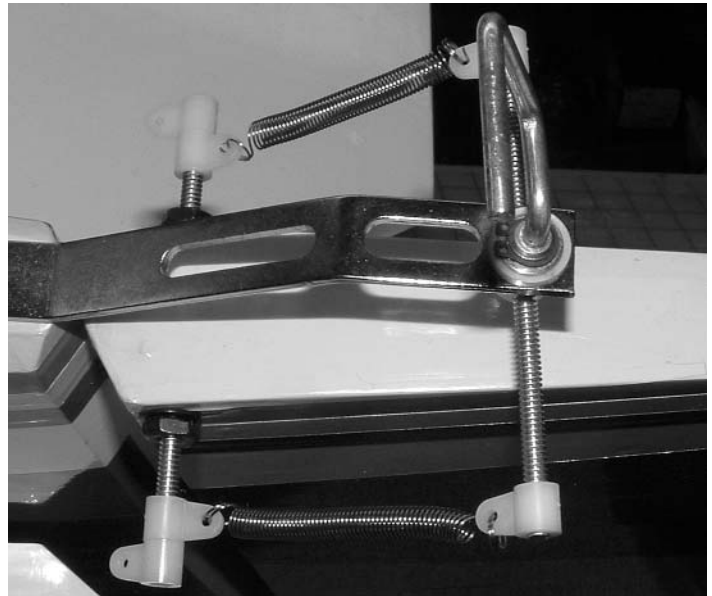

9.  Twist the end of the spring on to the horn bracket. Insert the long wire end around the second horn bracket. Twist the wire so that it will stay hooked to the bracket.
10.  Repeat steps 8 & 9.

**Note: The springs do not have to be tight to work. The wheel will pivot easily when ground taxing.**

- Install the tailwheel using the 1/8" wheel collars and set screws.

## RUDDER SERVO

1.  Collect the following items:
  - (1) Servo
  - (1) Cable
  - (2) Brass Tubes 1/16 OD x 1/4"
  - (2) 4-40 Rigging Coupler
  - (2) 4-40 Golden Clevis
  - (2) 4-40 Hex Nut
2.  Cut the rudder cable in half.



3.  Insert the cable into the hole found just above the elevator servo.
- Repeat for the other side cable.

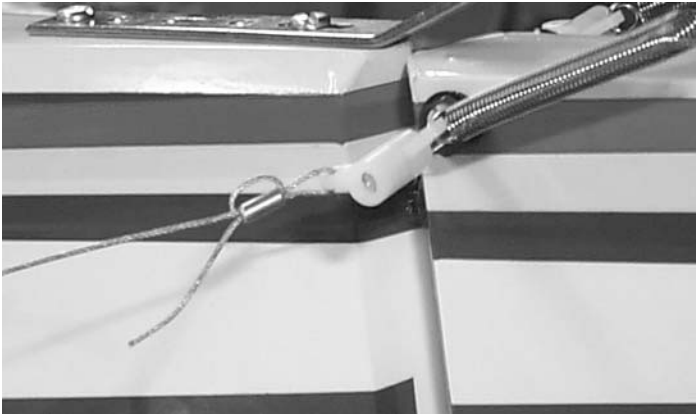

4.  Remove the top canopy hatch. Reach down inside the fuselage and pull the cables slowly forward.

**Caution: Do not pull the cables all the way through the hole.**

- Tape the cables to the rudder servo tray..
5.  Slide one of the brass tubes over the cable end next to the rudder.
- Loop the end of the cable through the outer horn bracket on the rudder control horn and back through the brass tube.
  - Once more loop the cable around the out side of the brass tube and pass it through the tube for the third time. (See the photo above)
  - Pull on the end of the cable to make the final loop as small as possible.
  - When satisfied then crimp the brass tube with pliers.
  - Repeat step 5 for the second cable on the other side of the rudder control horn.



6.  Install the rudder servo in to the rudder servo tray.

**Note:**  
**We have installed a double servo tray for better rudder performance. This is a option.**  
**We did not include the hardware for this option.**

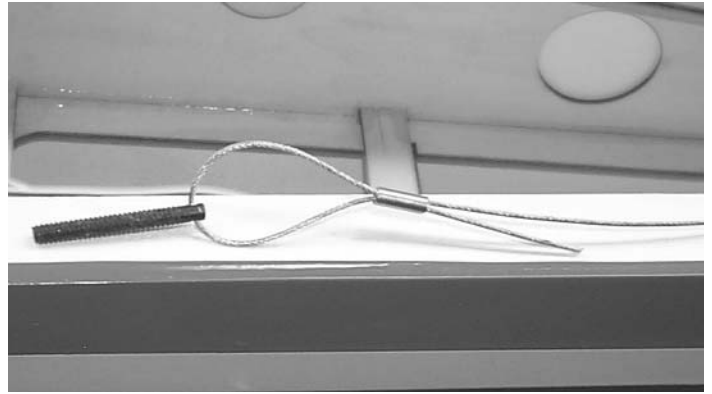

7.  Remove the cables from the servo tray.
- Insert the cable through the brass tube and then through the hole on the end of the rigging couplers.
  - Bend the end of the cable back through the brass tube.
8.  repeat step 7 for the other cable.



9.  Thread a 4-40 hex nut onto the rigging coupler.
- Thread a 4-40 metal clevis on to the rigging coupler.
  - Clip the clevis to the rudder servo arm.
  - repeat for the other cable.
10.  Pull on both cables till tight while keeping the rudder straight and the servo arm centered.
- When satisfied, loop the end of the cable through the brass tube and crimp the tube with pliers.
  - Tighten the hex nut against the metal clevis.

## INSTALLING MAIN LANDING GEAR

1.  Collect the following items:
  - (4) 3mm x 15 phillips Head Screw
  - (4) 3mm Lock Nut
  - (1) Main Aluminum Landing Gear



2.  Remove the landing gear cover from the bottom of the fuselage.
  - Insert the 3mm x 15 phillips head bolts through the aluminum mounting brackets on both sides of the fuselage.

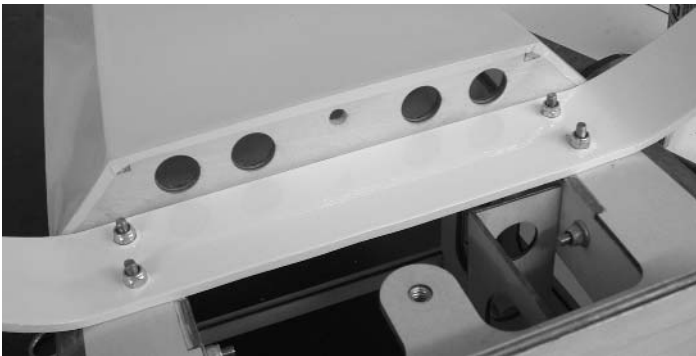

2.  Place the landing gear on the fuselage.
- Note: the landing gear should curve forward.**
- Thread the 3mm locking nut on to the bolt and tighten.
  - Repeat for the other three bolts
  - Reinstall the landing gear cover.

## WHEEL AND WHEEL PANTS

Collect the following items:

- (2) 5-32 x 1-1/4" Axle with Locking Nut
- (4) 5/32 Wheel Collars
- (4) 4-40 x 1/8" Cup Screws
- (4) 4-40 Blind Nuts
- (4) 4-40 x 1/2" Button Head Screws
- (2) 3-1/4" Wheels

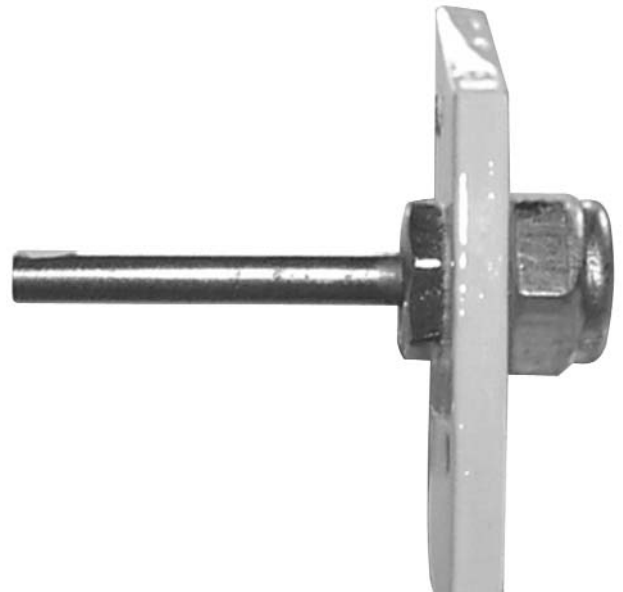

1. Mount the axle to the landing gears.

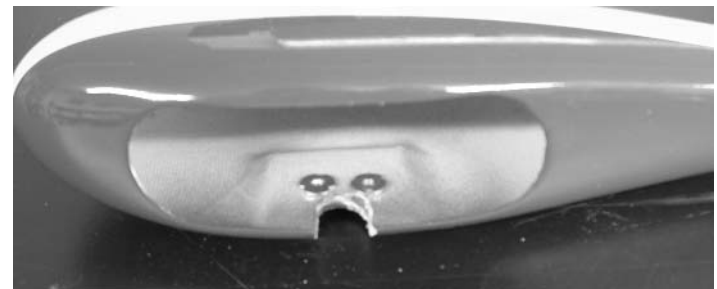

2. Place the wheel pant onto the axle.

3. Align the bottom of the wheel pant with the bottom of the landing gear.
4. Mark the hole locations on the wheel pants.
5. Drill 1/8" holes on the marks you just made.
6. Insert the 4-40 blind nuts inside the wheel pants.

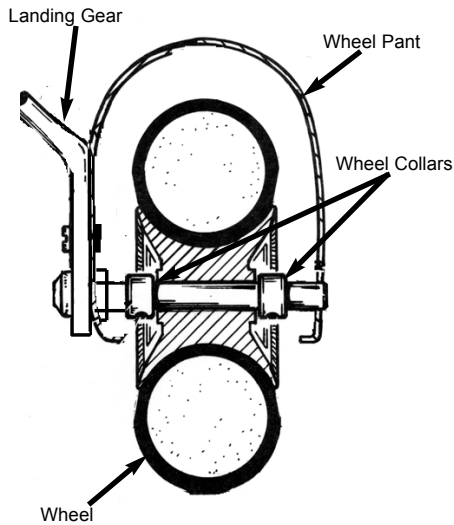

7. Mount the wheel pants back on the landing gear along with the wheel collars and wheels.

8. Center the wheel on the axle.

### ENGINE INSTALLATION

1.  Collect the following items:
  - (2) Motor Mounts
  - (1) Engine
  - (8) 8-32 x 1-1/4" phillips Head Screw
  - (4) 8-32 Locking Nut
  - (8) #8 Washer
  - (4) 8-32 Blind Nut

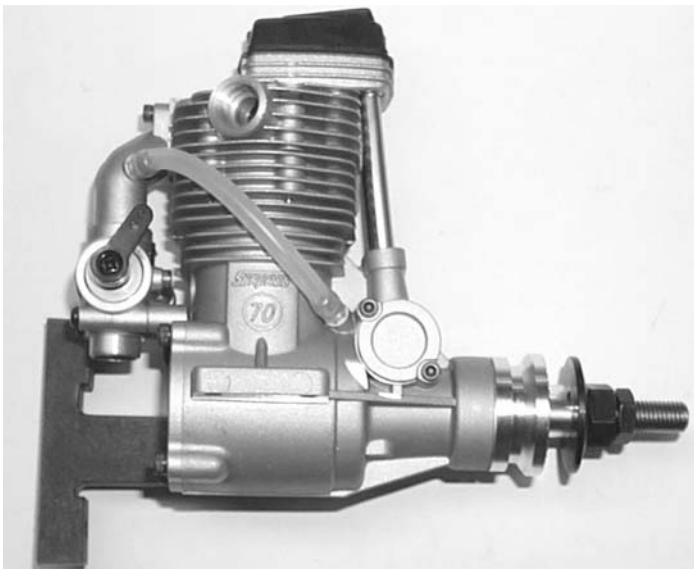

2.  Place you engine in the mounts and adjust till the prop drive washer is 5-7/8" from the fire-wall. Clamp the engine in place and and mark the location of the mounting holes. Drill using a 11/64" bit.
  - Screw the engine onto the motor mount using the 8-32 x 1-1/4" screws and locking nuts.



3.  Keeping the engine perpendicular to the table top, clamp the other motor mount to the engine. Mark and drill the second motor mount then screw the mount to the engine.

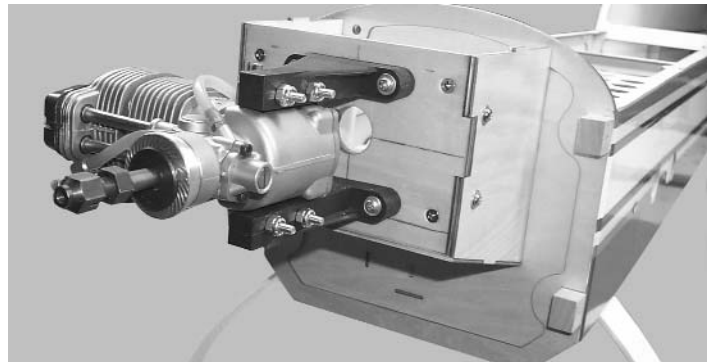

4.  Place the motor mount onto the firewall.
  - Center the motor over the horizontal and vertical lines.
5.  Install the motor mount beams on to the fire-wall plate using the 8-32 x 1-1/4" phillips Head screws and washers and 8-32 blind nuts

**USE THREAD LOCK ON ALL SCREWS**

## ENGINE THROTTLE INSTALLATION

1.  Collect the following items:
  - (1) 1/8" x 16" nylon tubing
  - (1) .072 x 18" Threaded Rod
  - (1) EZ connector
  - (1) Snap Nut
  - (1) 4-40 x 1/8" Screw
  - (1) Nylon Snap Link

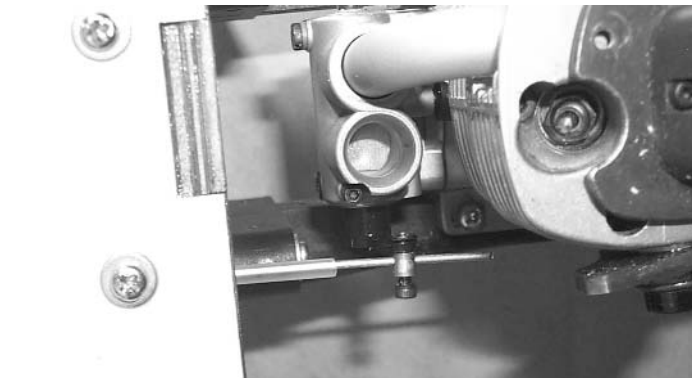
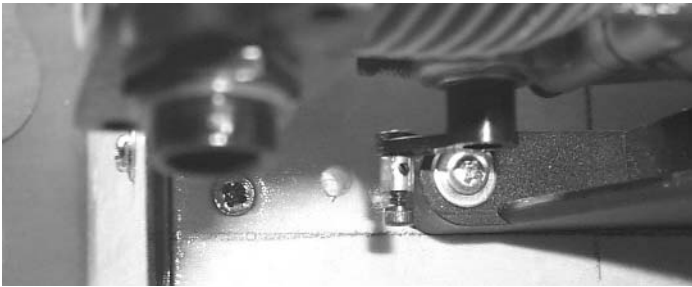

2.  Drill a 1/8" hole in the firewall in position with the throttle arm. Insert the 1/8" x 16" nylon tubing in the hole.
  - Let the tubing exit into the fuselage towards the throttle servo mount.
  - Attach the EZ connector to the engine throttle.
  - Insert the pushrod into the tubing and through the EZ connector.



3.  Install the throttle servo.

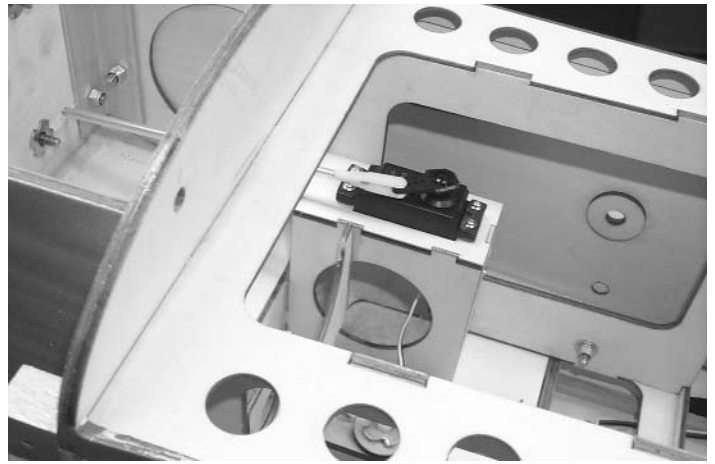

3.  Thread the nylon snap link onto the wire.
  - Attach the thread link to the servo arm.

## FUEL TANK ASSEMBLY



- Gather the following items
  - (1) fuel tank
  - (1) rubber tank stopper
  - (1) clunk
  - (1) 3mm x 25mm screw
  - (1) cap washer large
  - (1) cap washer small
  - (2) 3mm x 40mm brass tube
  - (1) 3mm x 60mm brass tube
  - (1) silicone tube 4mm x 80mm
  - (3) silicone tube 5mm x 165mm

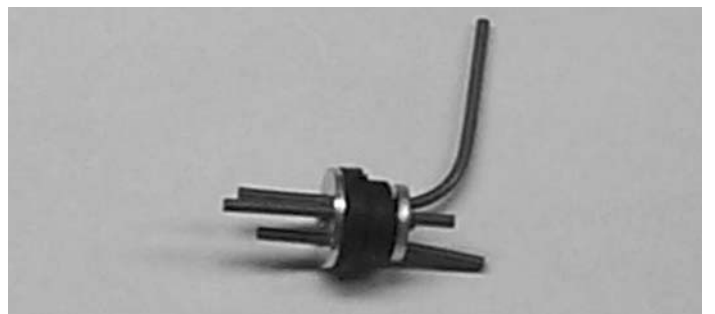

1.  Insert the 3mm screw through the center hole in the large washer, through the center hole in the rubber washer against the large side, and screw the small washer on the back side.

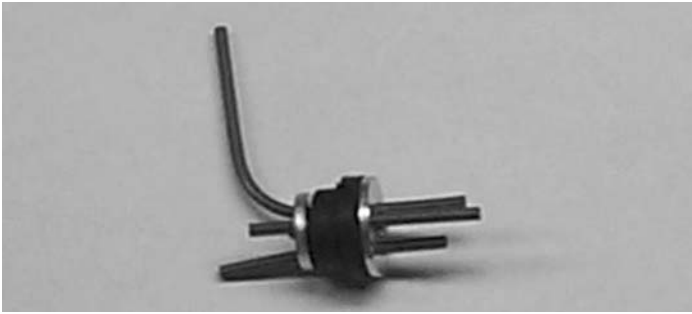

2.  Insert the brass tubes through three of the holes. They should be arranged so as the long one will be on the right side of the plane and the short one on the left side.
  - The tubes should extend out the front of the cap 5/8". Bend the long tube up at about a 20 degree angle. This should be adjusted so the end of the tube almost touches the top of the tank when installed.

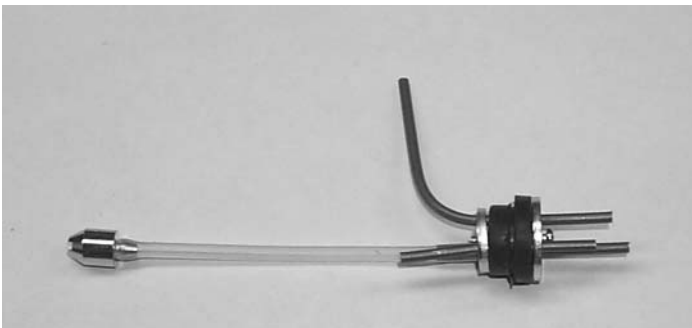

3.  Install the 4mm silicone tube to the short brass tube and install the clunk to the other end of the silicone tube. This is the fuel pick-up and must be free to "flop" around in the tank so it can pick up fuel in any attitude.



4.  Install the assembly into the tank so the vent tube is turned up to the top of the tank and is positioned on the right side of the tank. Tighten the screw to expand the rubber cap. Don't over tighten or you could split the tank.

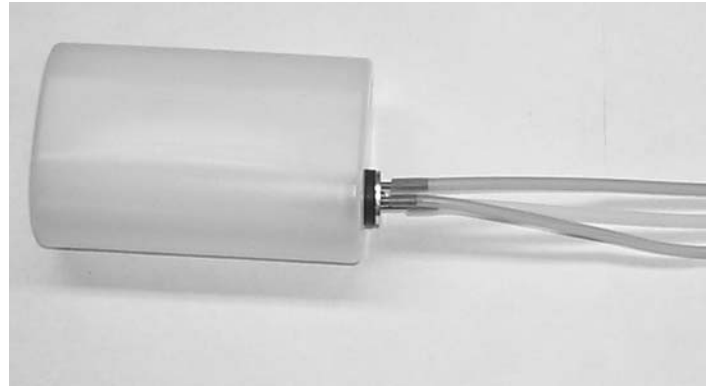

5.  Attach the three pieces of 5mm tubing to the three tank outlets. They are different colors so you can tell which are the two vents and which is the fuel pickup after the tank is installed. Make a note of which color you attach to which tube. The short brass with the clunk is the fuel pickup and must go to the carburetor. One of the long brass tubes is the vent and should go to the pressure outlet on the muffler. The second vent can be used for filling the fuel tank but will have to be plugged with a screw (Not Included) so that the fuel will not run out.

### INSTALLING THE FUEL TANK

1.  Collect the following items:
  - (1) Fuel Tank
  - (1) Fuel Line
  - (4) #2 x 5/16 phillips Head Screw
  - (1) Wood Hatch Cover



2.  Install the fuel tank into the fuselage.
  - Place some foam around the fuel tank (foam not included).

#### Note:

**If you are using a engine that needs to pressurize the fuel system then wrap the fuel tank in string reinforcing tape to prevent splitting when under pressure.**

**The tank provided is for glow fuel only.**

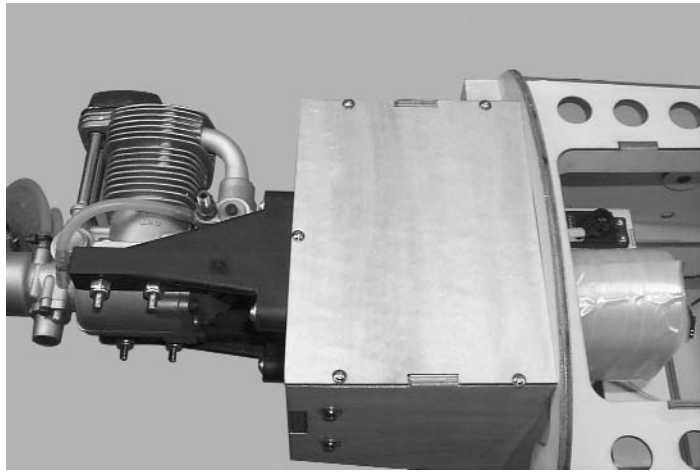

3.  Place the hatch cover over the motor box.
- Drill holes through the hatch into the ends of the motor box sides.
- Attach the hatch using the #2 x 5/16" screws.

### COWL INSTALLATION

1.  Collect the following items:
  - (1) Cowl
  - (4) 4-40 x 3/4" Socket Head Bolt
  - (4) #4 Washer

**You will have to remove any parts of the cowl that rub against the engine. Make these openings little at first and slowly make them bigger till the cowl fits over the engine with out touching. Do not forget to make an opening for the needle valve and the fuel lines.**



2.  Attach the cowl using the 4-40 x 3/4" socket head bolts and #4 washers.

### RECEIVER, BATTERY & SWITCH

We placed our receiver in front of the rudder servo and our 1200 Mah battery beside the fuel tank. The location of these items will vary with the engine used.

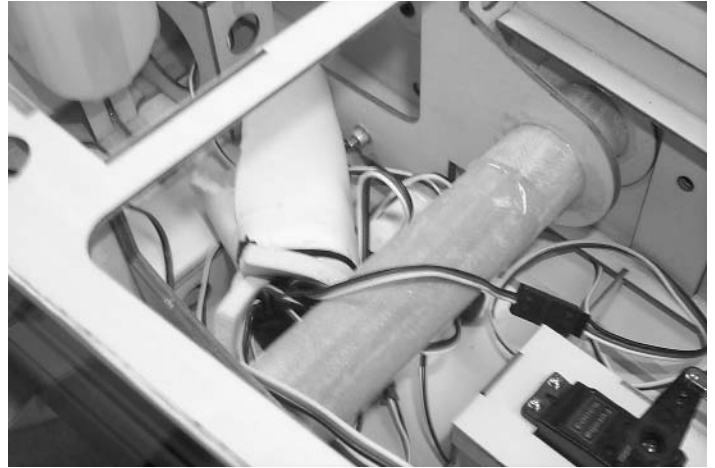

- Install your radio switch.
- Install your receiver and battery pack according to your radio instructions.
- The Extra 330 has lots of room to move the battery around to help with the CG. Do not make a final place till you have balanced the plane.

### WING BOLTS

1.  Gather the following items
  - (1) Right & Left Wing Panels
  - (2) 1/4-20 x 1-1/4" Nylon Bolt
  - (1) Wing Tube



2.  Slide the wing tube into one of the wing halves.
  - Slide the tube thru the fuselage.
  - Slide the second wing half onto the wing tube coming out of the fuselage side.
  - Push the two wing halves together till they are tight against the fuselage side.
  - Bolt the wing to the fuselage using a 1/4-20 nylon bolt.

### HATCH & CANOPY

1.  Gather the following items
  - (1) Canopy Hatch
  - (4) 4-40 x 1/2" Socket Head Bolt
  - (4) #4 Washer
  - (1) Canopy

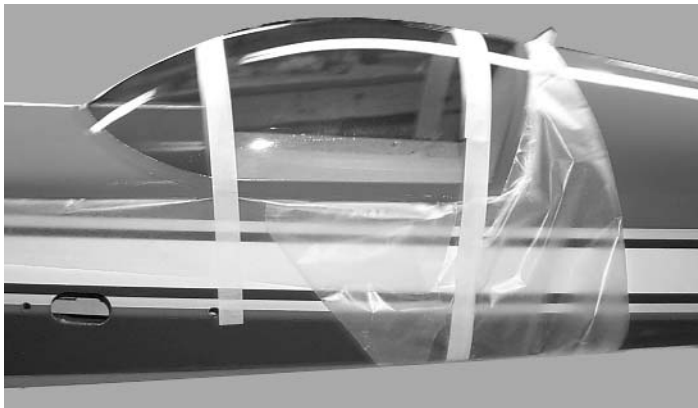

- Place wax paper between the hatch and the fuselage.
- Using the 4-40 x 1/2" bolts and washers, mount the hatch to the top of the fuselage.
- Put in place the canopy over the fuselage hatch.
- Glue in place using canopy glue..

## Balancing

Your model should balance at 5-3/4" to 6-3/4" back from the leading edge of the wing next to the fuselage. For extreme 3D flying you may want to move the CG back even farther after you are comfortable with the **Extra 330**. Just remember that the further back you go the more sensitive it will become. With extreme throws the model can get beyond the ability of novice pilots very quickly.

Start with the controls set at low rate with the ailerons plus or minus 1/2", the elevator plus or minus 1" and the rudder plus or minus 1-1/2". High rate should be all you can get.

Good Luck and I hope you enjoy flying the **Extra 330 ARF**.



# FLYING YOUR EXTRA 330 ARF

## FIELD KIT CHECKLIST

- Fully-charged flight batteries
- Radio transmitter
- 1 ½ volt starting battery & glo-plug clip
- Fuel bulb or pump
- Tools for tightening any parts that can vibrate and loosen
- Paper toweling for clean up
- Extra props and an extra spinner
- Prop wrench
- Bottle of CA glue

### CGP Super Tote



## PRE-FLIGHT ACTIVITIES

Prior to going to the flying field, with radio batteries fully charged, turn on both receiver (Rx) and transmitter (Tx) and actuate all controls many times until you are satisfied with all functions.

Before beginning each day's flying, make a range check of your equipment in accordance with the manufacturer's instructions. In general, with transmitter antenna collapsed to 6"-8", you should have an at least 100 foot range on the ground. To check this, turn on both the transmitter and the receiver switches, set the model heading away from you, and walk away while transmitting signals. Watch to see that no signals are missed until you are at least 100 feet away. Only if the equipment works perfectly should any flights be attempted. Again, be careful to not use your transmitter when anyone else at the field is flying or testing on the same frequency!

After the range check, stand behind the model and make sure the control responses are correct. Moving the control stick to the right should give right aileron movement up. Moving the stick back or down on the Tx should move the elevator up, and vice versa.

Check also to see that your wheels operate properly. Your throttle should open to permit full power when the stick or tab is moved forward or up. Finally, make sure that everything on your aircraft is neatly and firmly in place-motor fastened down, servos snugged down, receiver and battery wrapped in foam rubber, tank properly supported, etc. Prop and spinner must be tight. The receiver antenna must be extended, not coiled up inside the model. Nothing should be loose, or unfinished, or unchecked.

With everything ready, the engine should be started and broken in for a least a tank or two at no more than moderate speed. While the engine is running, make sure the control surfaces do not jitter or move until you command them and that the throttle also responds properly to your command.

# OBSESSION 3-D ARF™



Wing Span: 78-3/4"  
Fuselage Length: 70-1/2"  
Overall Length: 83-1/4"  
Wing Area: 1263 Sq. In.  
Flying Weight: 11-1/2 to 12-1/2 lbs.  
Engine: 120-140 4-Stroke  
Radio: 6 - Channel Radio  
6 - Standard Servos

## FEATURES

- 90% Pre-built
- Lightweight, all wood airframe
- Built-up Wing
- Double Beveled Control Surfaces
- Airfoiled Tail Group
- Tinted Canopy
- Decals
- Swept Aluminum Landing Gear & Tailwheel Assembly
- Painted Fiberglass Cowl & Wheel Pants
- Jig built with Lasercut Parts
- Premium iron-on covering
- All hardware included.

Experience extreme 3-D flying at its best! On low rates, she's smooth, graceful and precise, capable of performing a FAI pattern sequence with finesse. With a flip of the dual rate switch, she transforms into a fire-breathing 3-D monster performing an entire range of full-stall thrust vectored maneuvers with authority. Torque rolls, Waterfalls, Harriers, and High Alpha Rolls, the Obsession 3-D ARF™ does it all!

The Obsession 3-D ARF™ is a 120 size 3-D airplane that is a thrill to fly. Its oversized double beveled control surfaces deliver precision response, and the extreme throws you need for even the most difficult maneuvers. The Obsession™ is jig built with laser cut parts for accuracy & precision. Its lightweight all wood built up wing and airframe help the Obsession with its agility and ensures you're flying unlimited in any direction. Inside you'll find a fiberglass cowl and wheel pants, swept aluminum landing gear, and a complete hardware package. We've topped it all off with premium covering for a sharp looking finish.

Like every Goldberg ARF, The Obsession 3-D ARF is 90% prebuilt and quality hardware components are provided to make assembly a breeze. We believe you'll agree, the Obsession 3-D ARF is one of the most responsive, in-the-groove aircraft available!

Obsession 3-D ARF™ Kit #12090  
ARF comes with a complete hardware package, including fiberglass cowl & wheelpants, swept aluminum landing gear, tailwheel assembly, wheels, and fuel tank.



Features Goldberg's New Hardened Steel Nickel Plated Tailwheel Assembly.



Experience flying the Obsession 3-D ARF™ from Carl Goldberg Products.  
**CARL GOLDBERG PRODUCTS LTD.™**

Available at your local hobby shop!

P.O. Box 818, Oakwood, GA 30566 • 678-450-0085 • Fax: 770-532-2163 [www.carlgoldbergproducts.com](http://www.carlgoldbergproducts.com)

Pitts  
Model 12  
Monster

# Unlimited Aerobatics! PITTS MONSTER ARF



ARF kit comes with a complete hardware package, including Fiberglass Cowl & Wheelpants, aluminum landing gear, wheels, and fuel tank.

The Carl Goldberg Pitts Monster ARF is the biplane you've been waiting for. This 1.20 size Pitts is a semi scale reproduction of the original aerobatic show Pitts Model 12 Monster. Featuring painted aluminum landing gear, painted two color fiberglass wheel pants and 8 1/4" diameter round fiberglass cowl. It uses 4 independent servos for powerful aileron control. You'll find a 2 person cockpit layout for optional pilot and co-pilot and a sleek tinted canopy. The CG Pitts Monster ARF also features bolt on I struts, and pre-covered aluminum cabanes sheeted in wood for rock solid wing attachment and authentic finish.

#### The Perfect Mix

The CG Pitts Monster ARF's straight tracking and precise handling put it in a class above. It's

Wing Span: Top 60" Bottom 58"  
Wing Area: Top 555" Bottom 534"  
Fuselage Length: 48"  
Overall Length: 56"  
Flying Weight: 11 1/4 - 12 1/4 lbs.  
Engine: .90-1.08 2-Stroke  
120 4-Stroke  
Radio: 4 - Channel Radio  
7 - Standard Servos



Includes Goldberg's New Hardened Steel Nickel Plated Tailwheel Assembly and tail bracing wires.

smooth and docile until you throttle up, then you'll see what this Monster can do; with awesome snaps that start and stop instantly, knife-edge capability that's extraordinary, and slow rolls you can stretch from horizon to horizon.

#### Features

- Ultra lightweight, all wood airframe
- 90% Pre-built; Assembled from lasercut wood
- One-piece Wing
- Premium iron-on covering
- Painted Aluminum Landing Gear
- CG Hardened Steel Nickel Plated Tailwheel Assembly
- Painted Two Color Fiberglass Cowl and Wheelpants
- 2 Person Tinted Cockpit
- Decals Included
- All hardware included.

And just as quickly as you let it loose, you'll be able to calm it down for a feather-soft, slow-as-a-walk landing.

#### Traditional Goldberg Value & Quality

You'll know the Goldberg value in its quality craftsmanship and phenomenal aerobatic ability. Plus the CG Pitts Monster ARF has an all-wood airframe and all-wood one-piece wing assembly to ensure accurate and lightweight construction. Top this off with a complete hardware package, and a sharp color scheme from premium iron on covering.



Introducing The Pitts Model 12 Monster ARF From Carl Goldberg Products.

**CARL GOLDBERG PRODUCTS LTD.**

P.O. Box 818, Oakwood, GA 30566

Phone: 678-450-0085 Fax : 770-532-2163

Available at your local hobby shop!

[www.carlgoldbergproducts.com](http://www.carlgoldbergproducts.com)

© 2005 Carl Goldberg Products LTD

# GO FOR THE BLUE

## Hardened Steel Nickel Plated Tailwheels That Don't Bend or Sag.



Carl Goldberg Products' new tailwheels are made from hardened steel for unbeatable strength and are plated with polished nickel for a show finish. CGP tailwheel assemblies are available in 3 sizes; small size for 6-12 lb. airplanes, medium size for 10-18 lb., and large for 16-35 lb. airplanes.

## What if every landing was this solid?

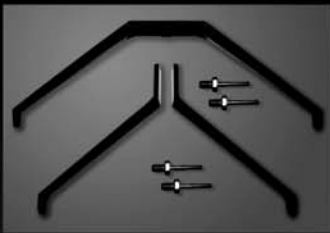

Goldberg Main Landing Gears are light weight and extremely durable. Premolded glass filled reinforced, they mount easily and can take a beating. CGP Main Gears for .40 to .60 size airplanes measure 14 3/8 inside axle, 3 7/16 across the mount, and 5 tall. CGP Profile Gears for .40 size airplanes measure 5 1/2 from center to axle and 6 15/16 tall. Axles are Included.

## Spinner Nuts

Goldberg Spinner Nuts are top quality and available in assorted sizes. Choose from four anodized finishes (black, red, blue, yellow) or Polished Nickel Chrome finish. Larger diameter sizes have hex socket for easy tightening.



## Adjustable Motor Mounts with Nosegear

Goldberg's New Adjustable Motor Mount and Adjustable Motor Mount with Nosegear are the perfect fit for .25 - .50 2 Stroke Engines.

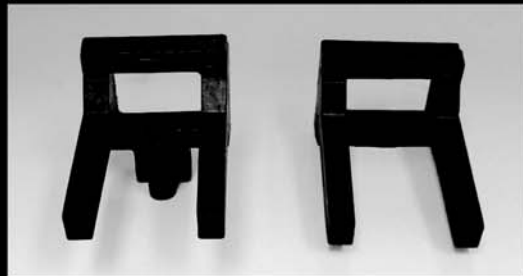

## Simple To Use.

Snap-on Spinners.™ Seven sizes, five colors, four-pin cone-to-backplate mounting, larger prop cutouts plus unmatched precision of balance and fit!



Jet Model Mate fills the grain in wood and seals holes in fiberglass, helping you create the perfect finish. And unlike other fillers, Jet Model Mate's special adhesion qualities come without excessive weight, and it's unsurpassed for strength and sandability. Jet Model Mate is available in both balsa tint and white.

## Model Mate™



Landing Gears & Accessories From Carl Goldberg Products.  
**CARL GOLDBERG PRODUCTS LTD.**

P.O. Box 818, Oakwood, GA 30566

Info: 678-450-0085

Fax : 770-532-2163

Available at your local hobby shop!

[www.carlgoldbergproducts.com](http://www.carlgoldbergproducts.com)

© 2004 Carl Goldberg Products LTD.